



Calypso
4.10.04.04

Carl Zeiss

Date: April 7, 2010
Order: 111-PHX-02-3701

Part Number
219

CMM
ACCURA

Drawing No.
* drawingno *

Department:
Operator: Master
Signature:

Measurement Plan
Phenix FVTX back plane 3701 R

CAD View

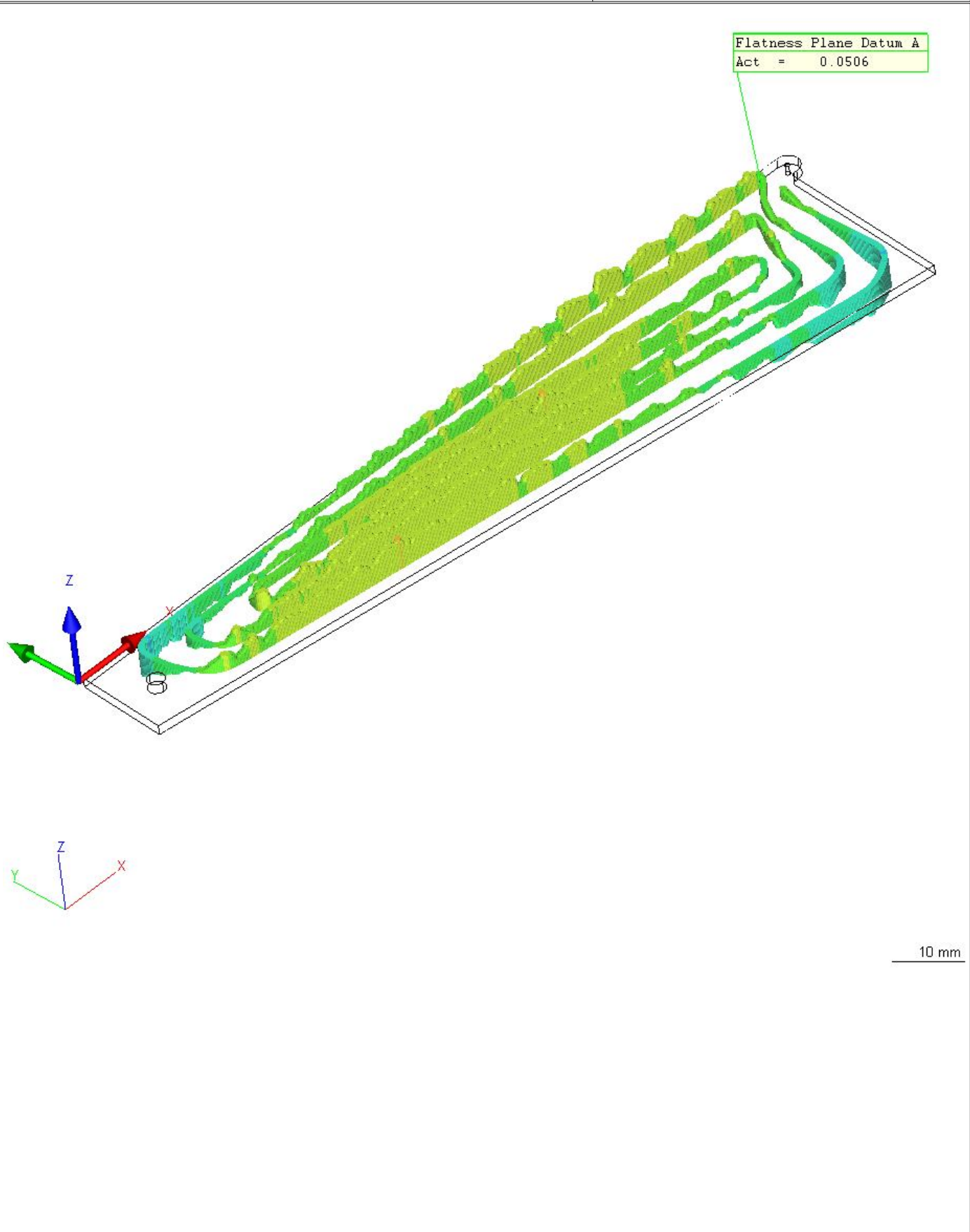



Calypso
4.10.04.04

Carl Zeiss

Date: April 7, 2010
Order: 111-PHX-02-3701

Part Number
219

CMM
ACCURA

Drawing No.
* drawingno *

Department:
Operator: Master
Signature:

Measurement Plan
Phenix FVTX back plane 3701 R

CAD View

Flatness Plane Opposite A
Act = 0.0486

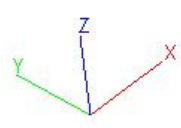
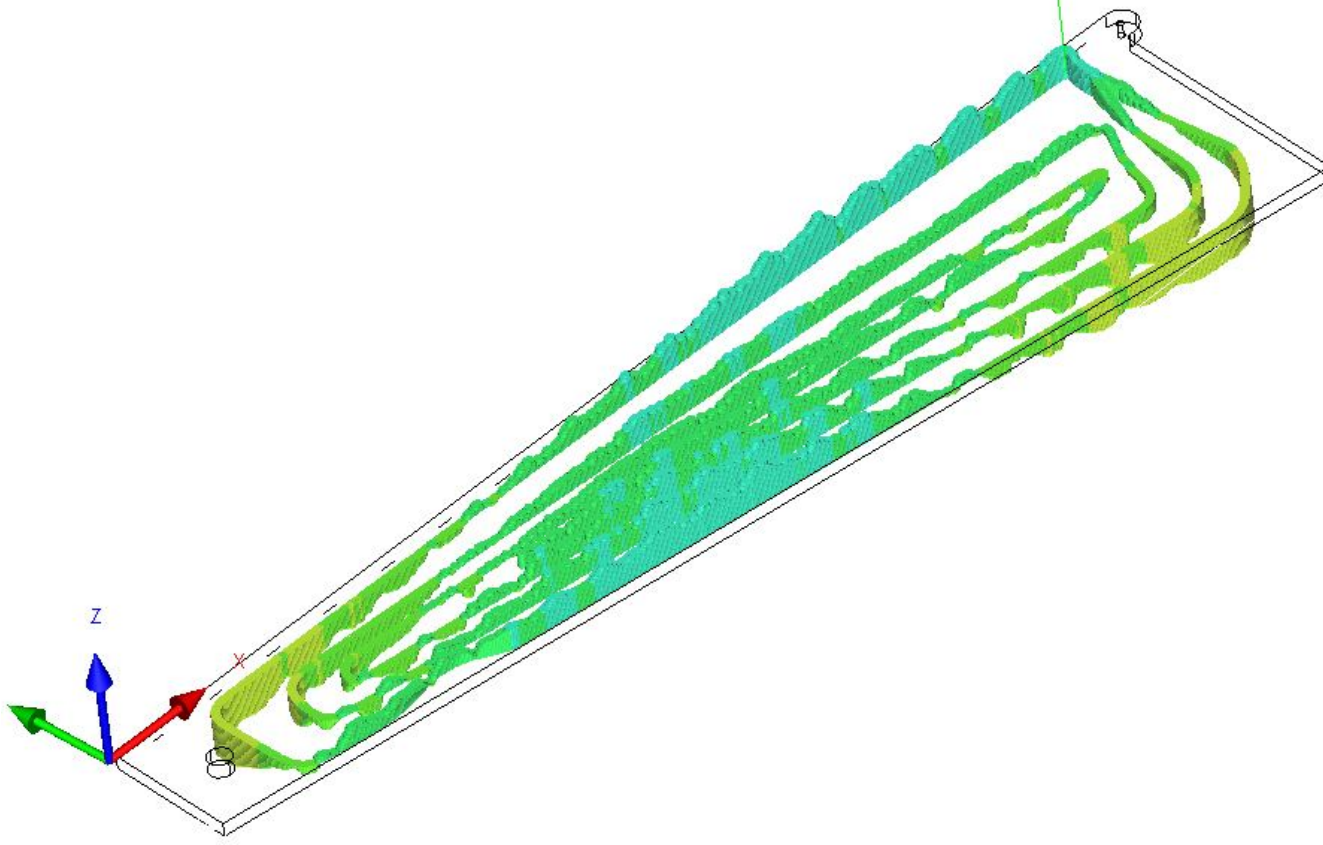

10 mm