



Calypso  
4.10.04.04

# Carl Zeiss

Date: April 7, 2010  
Order: 111-PHX-02-3701

Part Number  
231

CMM  
ACCURA

Drawing No.  
\* drawingno \*

Department:  
Operator: Master  
Signature:

Measurement Plan  
Phenix FVTX back plane 3701 R

CAD View

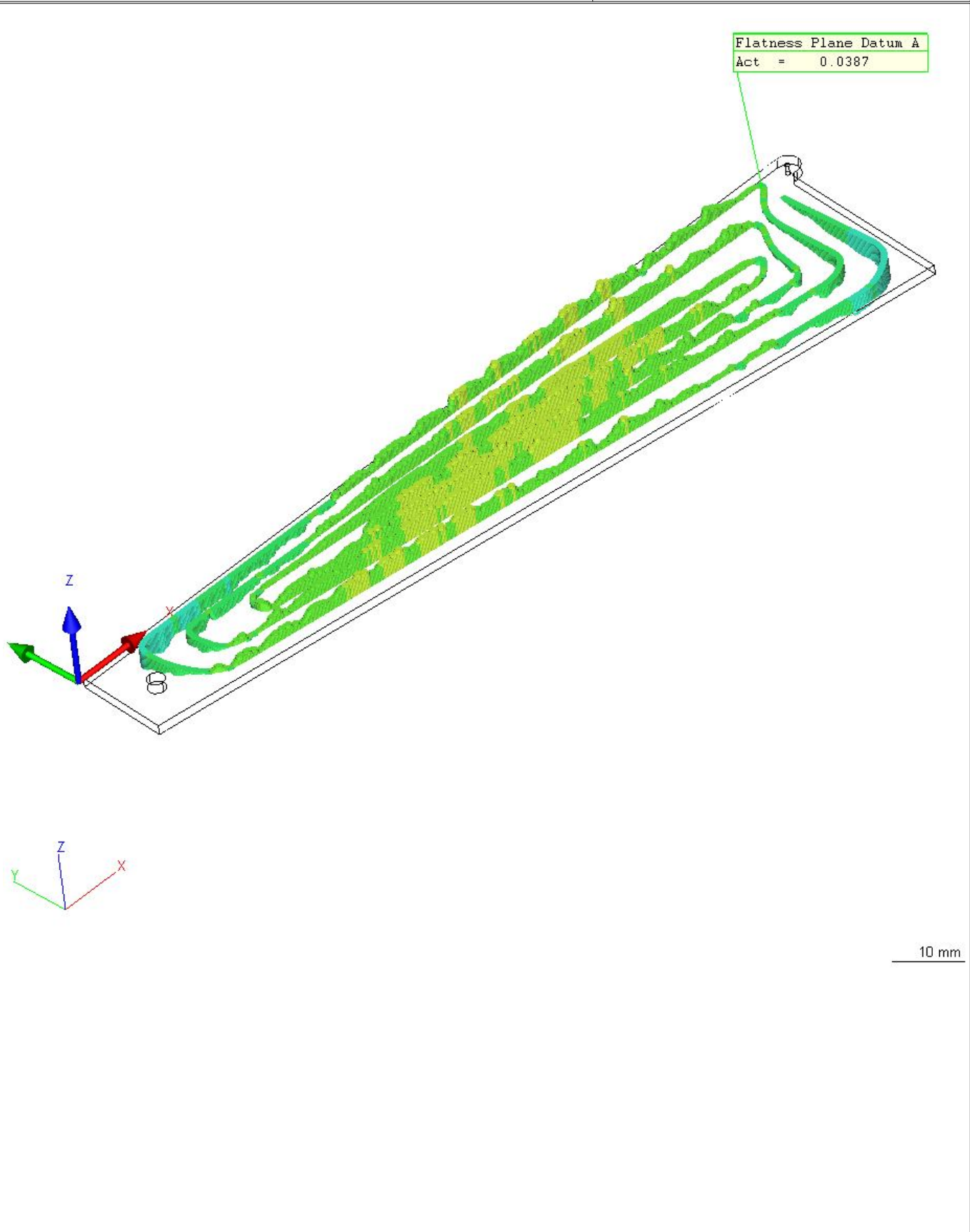



Calypso  
4.10.04.04

# Carl Zeiss

Date: April 7, 2010  
Order: 111-PHX-02-3701

Part Number  
231

CMM  
ACCURA

Drawing No.  
\* drawingno \*

Department:  
Operator: Master  
Signature:

Measurement Plan  
Phenix FVTX back plane 3701 R

CAD View

Flatness Plane Opposite A  
Act = 0.0381

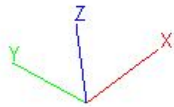
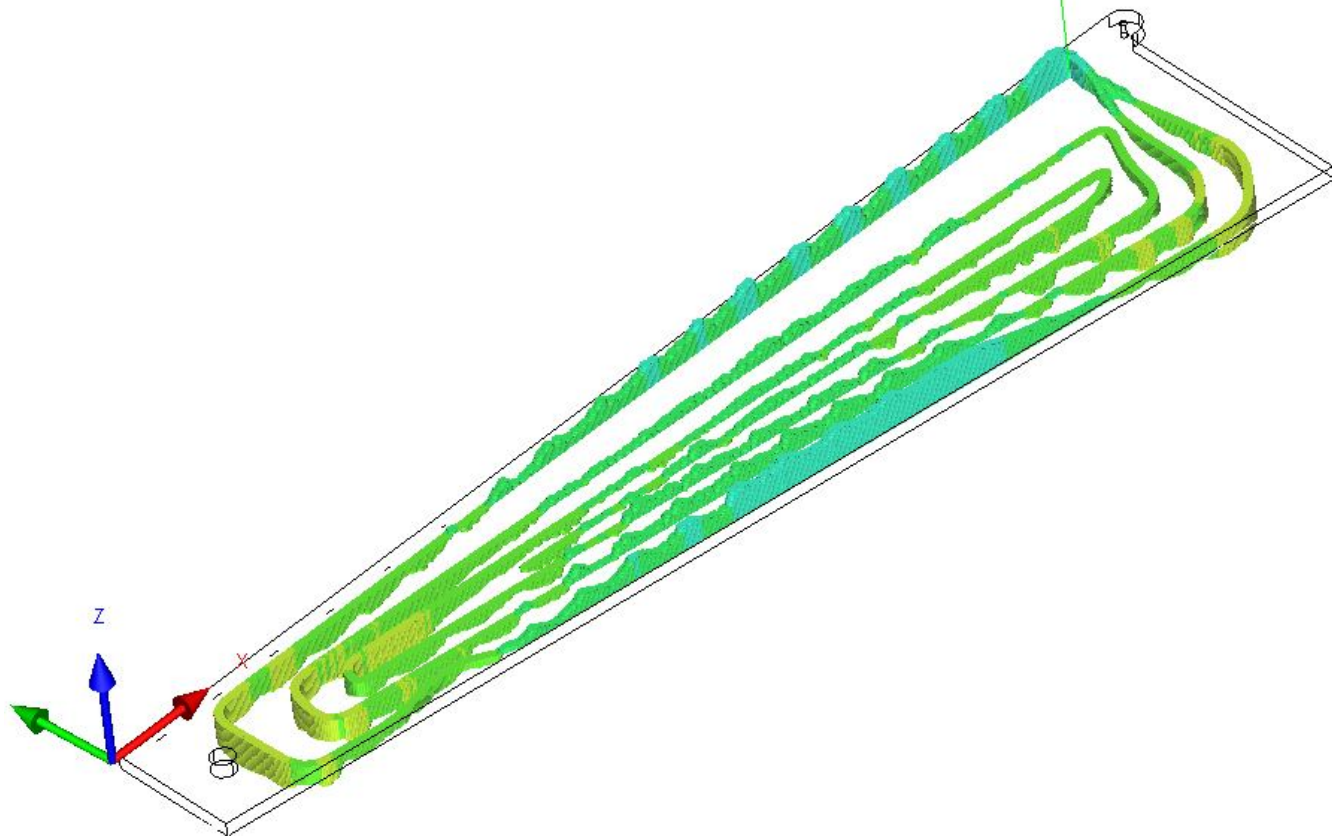

10 mm