

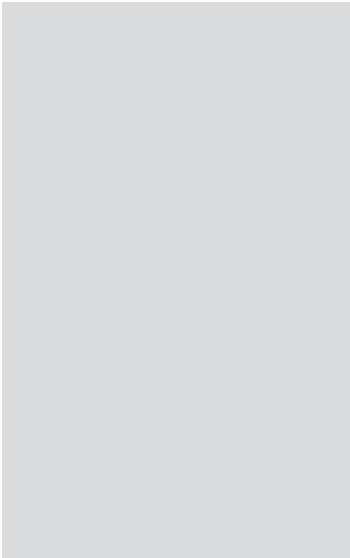

The lamp book

The Heraeus Noblelight technical reference book for arc and flash lamps.



"Heraeus Noblelight has always been known for quality lamps. Today, as the importance of support grows for laser manufacturers, an excellent standard in customer service has become part of our quality philosophy."

Laser excitation lamps in a new light

Noblelight was founded by John Littlechild in 1976

based on the premise that innovation can only be

driven by close collaboration with the customer.

We pioneered laser lamp manufacturing and electrode

technology including the HI-CHARGE Cathode®.

Since 1986, Noblelight has been part of the Heraeus

group with access to advanced lamp manufacturing

technology and quartz glass expertise.

Today, Heraeus Noblelight Ltd. not only has the most

advanced automated laser lamp manufacturing line,

but also keeps exploring new ways to improve lamp

performance with research institutes and, most

importantly, our customers. We invest in enlarging our

production capacity as more and more customers

turn to us for high quality products and professional

service. Applications of our products include not just

laser technology, but also areas like cosmetics and

Rapid Thermal Processing of silicon wafers.

We provide close personal service to laser system

manufacturers and users. Our experienced team of

engineers and customer service experts will assist

you from consultancy and design through to on-time

delivery from our in-house manufacturing in

Cambridge.

Heraeus Noblelight has produced this technical reference book as a guide to designers, as there are key construction aspects which warrant careful consideration when designing a lamp.

This book follows the same information sequence as the technical data sheet (see page 39) which provides Heraeus Noblelight's R&D team with the necessary information to design lamps to match customer needs precisely.

As you fill in each section of the form, please read the corresponding section in the book.







The R&D team at Heraeus Noblelight is poised to help with any questions you may have.

Please contact:

(+44) 1223 423324.



The lamp book The Heraeus Noblelight technical

	Lamp seals	6
	Solder, Ribbon, and Rod Seals	6
	Electrodes	7
	The anode	7
	The cathode	7
	Cathode types	7
	Gas fill and pressure	10
	Pulsed lamps	10
	Continuous Wave lamps	11
	Envelope materials	13
	Quartz types	13
	Power calculations	14
	Tolerances	15
	Lamp Triggering	16
	Series triggering	16
	Parallel triggering	17
	External triggering	17
	Continuous lamp operation	18
	Operation	18
	CW lamp design parameters	19
	Pulsed lamp operation	21
	Pulse forming network operation	21
	Current curves	23
	Square Wave operation	24



Lamp cooling 28

- Convection air cooling 28
- Forced air cooling 28
- Fluid cooling 28



Lamp finishing and terminations 30

- Materials 30
- Positioning 30
- Lamp mounting 30
- Trigger wires 30



Lamp lifetime 31

- Failure mechanisms 31
- Electrode erosion 31
- Gas fill contamination 32
- Glass to metal seal failure 32
- Envelope ageing 33
- Lifetime calculations 33



Glossary 34

Lamp coding 35

Lamp assembly 35

Lamp formulae 36

Conversion factors 37

Technical data sheet 39

Contents

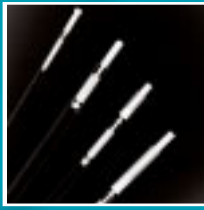

Lamp seals

In order to achieve the necessary hermetic structure, there are three main sealing techniques used in arc lamp manufacture – ribbon seal, solder seal and rod seal.

Solder Seal

The Solder Seal or End Cap Seal (figure 1) is created by soldering a circular Invar band around the end of a quartz tube. The lamp can be designed with a small dead space and a coolant channel within the electrodes. Because of the low melting point of the Lead Indium solder, however, the operating temperature must be limited to around 100°C.

These lamps cannot be used in high average power applications. The use of high temperature processing during manufacture is also prevented, thus lamps with this sealing technique tend to have a shorter life than those with alternative seals.

Ribbon Seal

The Ribbon Seal (figure 2) is formed by shrinking quartz directly onto a thin foil of Molybdenum. This thin foil is necessary

to prevent the seal cracking due to unequal expansion rates between Molybdenum and quartz.

This seal produces a very rugged lamp with no dead space, but its peak and RMS current are limited (max. RMS current ~20Amps).

Rod Seal

The Rod Seal (figure 3) is by far the most commonly used of the lamp seals. It is created by wetting a sealing glass directly onto the unoxidised surface of a Tungsten wire, hence it is also called Bright Seal.

This sealing technique allows for high temperature and high vacuum processing during manufacture, ensuring a lamp that has the performance and reliability demanded by today's customers. The seal can withstand long-term operating temperatures up to 250°C and 600°C for short periods, and can also withstand high peak and RMS currents.

The Rod Seal has become the industry standard for high performance, continuous and pulsed arc lamps.

Lamp seals	6
Electrodes	7
Gas fill and pressure	10
Envelope materials	13
Lamp triggering	16
Continuous lamp operation	18
Pulsed lamp operation	21
Lamp cooling	28
Lamp finishing/terminations	30
Lamp lifetime	31
Glossary	34
Lamp coding	35
Lamp assembly	35
Lamp formulae	36
Conversion factors	37
Technical data sheet	39

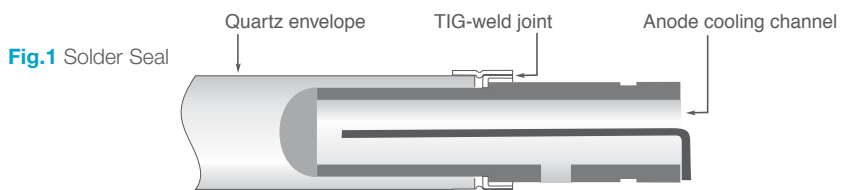

Fig.1 Solder Seal

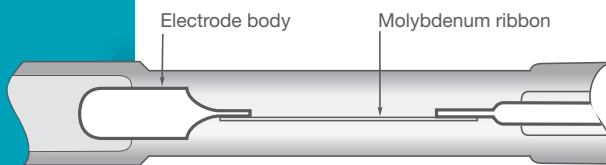

Fig.2 Ribbon Seal

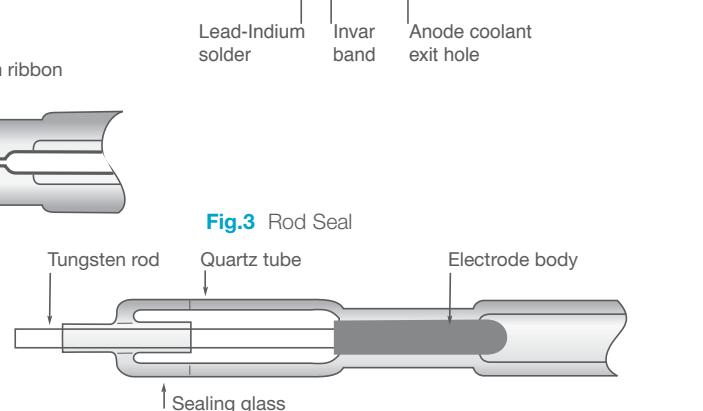

Fig.3 Rod Seal

Electrodes

In the lamp, the transformation of electrical energy into a light emitting plasma takes place at the electrodes. For the electrode design to be considered effective, this transfer must be efficient, and the resultant arc must be reliably controlled for maximum lamp life and system performance. With this in mind, the importance of the electrode should not be overlooked.

The anode

The simplest of the electrodes is the anode, made of high purity Tungsten doped with a rare earth oxide. The dopant aids the machining of the electrode which would otherwise be difficult (pure Tungsten is very brittle). The anode's primary purpose is to receive the charge emitted by the cathode and hence complete the electrical circuit.

Care should be taken when considering shape. The anode must have a large tip area that is in proportion to the power it receives. It should also have a shape that holds the arc in the centre of the lamp's bore at all times. Where the arc is allowed to drift close to the quartz, an excessive thermal loading is caused which rapidly ages the quartz and consequently reduces the lamp's life.

The cathode

Like the anode, the main body of the cathode is manufactured from doped Tungsten, however a separate tip is brazed onto the main body of the electrode. While this tip only forms a small part of the lamp's construction, it is arguably one of the most important features of the lamp.

The tip of the cathode is made of porous Tungsten. This porosity is tightly controlled during the manufacturing process, when the loose powder is

compressed, under massive pressures, to form the tip.

At the time of writing, Heraeus Noblelight is the only laser lamp manufacturer to carry out this process in-house, where it is controlled to a precise degree. The porous Tungsten matrix is then impregnated with a dopant, again to a defined level.

The dopant is a proprietary powder having a low work function, to ease the emission of electrons and reduce the temperature for an extended cathode lifetime. Depending on the lamp's application, the level of doping used needs careful consideration - Engineers at Heraeus Noblelight can advise on this. For instance, in the case of a continuous wave (CW) lamp, there is a high concentration of dopant on the surface of the cathode to aid the lamp's operation. Yet in the case of pulse lamps where there is a high peak current and a long pulse, the amount of emissive material on the surface of the cathode should be limited.

Providing consideration is given to the above, cathode break-up is reduced, thus increasing the lamps' life.

The Hi-Charge™ cathode

Heraeus Noblelight's patented High Charge Transfer design (figure 6) represents an exclusive development in cathode technology that today remains unrivalled in the lamp industry.

This innovative technology allows Heraeus Noblelight Design Engineers to fine-tune the temperature of the emitting surface of a cathode for optimum performance. Figure 4 demonstrates the increased lifetime over competitors' lamps in relation to charge transfer.





Electrodes continued

Lamps which are operated using a square wave pulsed power supply can be prone to premature ageing because of thermal cycling in the cathode tip. This occurs due to the relatively long time periods between the high power pulses. The Hi-Charge™ design developed by Heraeus Noblelight limits thermal cycling and the associated ageing by incorporating a thermal choke in the neck of the cathode. This restricts thermal energy flow out of the cathode between pulses and stabilises the operating temperature.

By varying the width of the cathode neck, the operating temperature of the cathode can be moved through a range until an optimum is achieved. Figures 4 and 5 demonstrate the difference between a Heraeus Noblelight lamp and the industry standard when a square wave pulse is applied.

Figure 5 illustrates the lower fluctuation in temperature of the Heraeus cathode. The operating temperature of the Hi-Charge™ cathode can be raised or lowered by manufacturing the cathode neck with different diameters.

The Standard Pulse cathode

In simple terms the Standard Pulse cathode is a Hi-Charge™ cathode without the thermal choke (figure 7). In practice however, the manufacturing processes are slightly different to

optimise performance.

This cathode has been developed specifically for use in systems using a Pulse Forming Network (PFN) power supply. The design of this supply differs from that of a square wave unit. Instead of using high power electronics to manipulate the power waveform, a bank of capacitors and inductors is charged and then discharged through the lamp to form the pulse.

PFN power supplies generally deliver pulses of a lower power than those in a square wave unit, the pulses having a curved waveform (half sinusoidal) rather than a square shape. The exact shape of the pulse depends upon the damping (ζ) of the circuit as detailed in the Pulse section (see page 21).

As well as having lower power, the pulses generated by a PFN network tend to be shorter, with pulse widths measured in the microsecond range rather than in milliseconds. Where lower power, high frequency, short pulses are applied to the lamp, the thermal loading per pulse is considerably less than would be seen in a Hi-Charge™ application, thus the change in cathode temperature between pulses is much less.

The strain on the cathode material caused by temperature oscillation is thus considerably reduced and the use of a thermal choke is unnecessary.

Lamp seals	6
Electrodes	7
Gas fill and pressure	10
Envelope materials	13
Lamp triggering	16
Continuous lamp operation	18
Pulsed lamp operation	21
Lamp cooling	28
Lamp finishing/terminations	30
Lamp lifetime	31
Glossary	34
Lamp coding	35
Lamp assembly	35
Lamp formulae	36
Conversion factors	37
Technical data sheet	39

Fig.4 Lamp lifespans

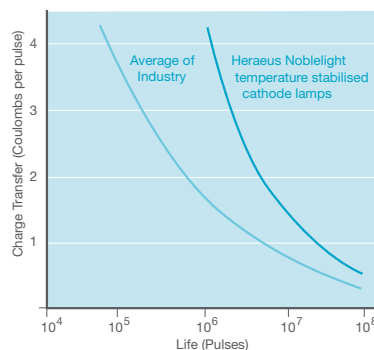
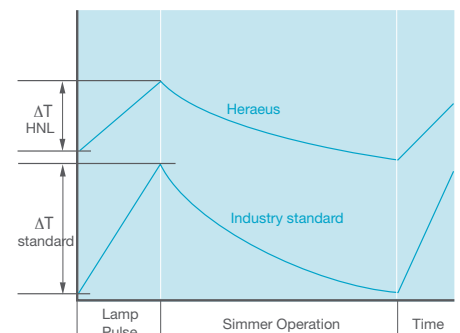

Fig.5 Temperature fluctuation



The Air-Cooled cathode

This cathode (figure 8) is a derivative of the Standard Pulse cathode. Lamps used in low power applications, where the rise in temperature of the lamp during operation remains minimal, require little or no cooling other than local airflow. The use of a large Tungsten mount to provide a sink transferring heat away from the cathode tip is therefore unnecessary, as normal thermal radiation through the quartz body will keep the electrode temperature at an acceptable level.

Put simply, in the case of an air-cooled lamp, the mount is completely omitted and the tip is brazed onto the Tungsten wire.

The Continuous Wave (CW) cathode

Until recently the term 'CW' referred to lamps operating at pre-set current values with either no, or very low frequency changes to that value. It is hardly surprising therefore, that just one type of cathode was used.

More recently this situation has changed. Now a number of different running parameters exist which fall under the label of CW operation (see page 18). Heraeus Noblelight has risen to the challenge of these new operating parameters by developing a number of different cathodes in response to market demands. The cathode in figure 9 is the standard CW design for applications where the lamp current trace remains flat, with little or no change during operation.

This design effectively retains the arc in the centre of the lamp bore during operation. The angle of the cathode has also been specifically engineered so that, during operation, the tip remains at the optimum temperature for efficient emission and maximum life.

A variation on this cathode is illustrated in figure 10. This has been developed for quasi-CW operation as described on page 19. The key difference between the two cathodes is the quasi-CW cathode's rounded end.

The rounded end design was developed in response to a tendency for the tip end to form a ball of molten metal and detach when a standard CW cathode was used in quasi operation. The rounded tip design spreads the heat load during operation, and thus prevents a ball of molten metal forming.

In the case of modulated CW operation, as described on page 19 the cathode design is significantly different to the models outlined overleaf. This cathode, (figure 11) is the result of considerable research and development by Heraeus Noblelight and leads to a significant increase in lamp lifetime.

One major problem with modulated CW operation is the tendency of the arc to wander around the tip circumference when the lamp is in the low current section of its operation cycle. This results in the quartz immediately next to the electrode suffering very high thermal loading, causing rapid ageing.

This cathode design largely prevents this happening. The shape prevents the arc from wandering and because the tip is relatively far away from the quartz, it dramatically reduces any possibility of damage.



Fig.6 Hi-Charge cathode

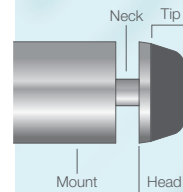

Fig.7 Standard Pulse cathode

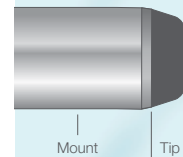

Fig.8 Air-Cooled cathode

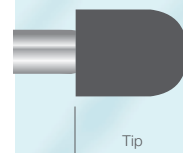

Fig.9 Continuous Wave (CW) cathode

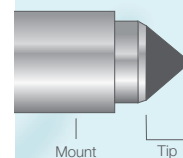

Fig.10 Quasi-CW cathode

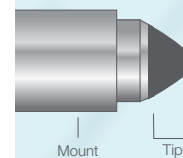
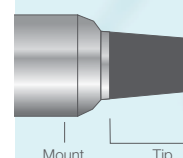

Fig.11 Modulated CW cathode





Gas fill and pressure

When designing an arc lamp, the gas fill and pressure can be varied to suit the specific application for which the lamp is to be used.

Pulsed lamps

The laser pump lamp's spectral output characteristics should match the absorption spectrum of the laser material as closely as possible. Figure 12 shows the absorption spectrum of Nd:YAG – one of the most widely used solid state lasing media.

The lamp's spectral output is determined largely by current density (ie the amount of current flowing per unit of cross-sectional area of the lamp). Current density is given by the expression

$$\frac{4I}{\pi d^2}$$

d is the bore diameter of the lamp and I the current through the lamp. The unit of current density is amps per square centimetre (Acm^{-2}).

In a pulsed lamp the amount of current flowing changes over time, increasing from zero (or a very low value) to a maximum, and then decreasing, each time the lamp is pulsed. As such, the spectral output also varies over time. Graphical representation of this variance is usually a time-integrated plot of the lamp's output.

Because of this time variation, a useful expression called the ' $E_0 \cdot TA$ ratio' is sometimes used to describe the loading rather than current density of a pulsed lamp, which does not include a term to take into account time dependence. The unit of this ratio is watts per square centimetre (Wcm^{-2}) and so it is a measure of power density rather than current density. E_0 is the pulse energy in Joules (J) and T the pulse width in seconds (s).

The area (A) in this ratio refers to the internal surface area of the lamp envelope in the discharge region (approximately πdL_A where L_A is the arc length of the lamp) and not the cross-sectional area of the lamp bore, which is the area used in measuring current density.

A continuum of radiation accounts for a large proportion of the total spectral output of a pulsed lamp. This is especially evident when the lamp is driven at high power densities. The continuum is a result of radiation generated by free-bound transitions (ions recombining with free electrons) and free-free transitions (electrons and ions decelerating upon collision).

Line spectra in the near-infrared are more dominant at lower power densities of around $2500Wcm^{-2}$, where bound-bound transitions (transitions between bound energy levels of atoms and ions) dominate. Examples of these phenomena are shown in figure 12.

It is interesting to compare the spectral output of pulsed lamps filled with Xenon with those filled with Krypton. It is clear from a comparison between the graphs in figure 12, why Krypton is generally chosen as the gas fill for pulsed lamps driven at low power densities (typically below $16,000Wcm^{-2}$).

The line spectrum matching the Nd:YAG absorption spectrum is clearly more dominant in these lamps at such low power densities - even though Xenon does have a better total conversion efficiency from about 200 to 1100nm.

At power densities greater than $16,000Wcm^{-2}$ however, Xenon may become more efficient as an optical pumping source of Nd:YAG. The reason for this is that as power density is increased, continuum radiation begins to

Lamp seals	6
Electrodes	7
Gas fill and pressure	10
Envelope materials	13
Lamp triggering	16
Continuous lamp operation	18
Pulsed lamp operation	21
Lamp cooling	28
Lamp finishing/terminations	30
Lamp lifetime	31
Glossary	34
Lamp coding	35
Lamp assembly	35
Lamp formulae	36
Conversion factors	37
Technical data sheet	39



dominate and near-infrared line structure contributes a smaller fraction of the total.

Because Xenon has a better overall conversion efficiency than Krypton at such elevated power densities, it becomes more efficient as a radiator of Nd:YAG absorption wavelengths.

The Laser Designer's goal is usually to obtain maximum laser efficiency - ie to get the best conversion of electrical input power to optical output power.

Output power level is dependent on both the conversion efficiency of the lamp and

on the overall efficiency of the entire laser system, thus conversion efficiency in the lamp is obviously critical. Any losses here cannot be recovered at a later stage in the system.

Conversion efficiency however is a complex concept. The overall conversion efficiency - ie the proportion of electrical input energy that is actually converted to optical output energy in the 200 to 1100nm range - is not necessarily the critical parameter that governs optical pumping efficiency.

The important conversion factor is that which corresponds to the laser material's absorption wavelengths. Whereas the overall conversion efficiencies of pulsed lamps can be in the 50-80% region, efficiencies over the narrower Nd:YAG absorption region can be lower - typically only 5-10%, resulting in conversion to laser output of 3-7%.

As figure 15 shows, conversion efficiency will increase along with fill pressure up to a saturation point, but the disadvantage is that the lamp requires a higher trigger voltage and the simmer current will be more difficult to establish and maintain.

Default fill pressures in pulsed lamps are around 450 Torr in Xenon lamps and 700 Torr in Krypton lamps.

Continuous Wave lamps

Krypton is the usual gas fill in CW laser lamps. Although its overall conversion efficiency of electrical energy into light energy is less than that of Xenon, it has the advantage of specific line radiation which matches the absorption peaks of Nd:YAG at the relatively low current densities employed in CW lamps.

Current density, in this context, is the amount of current flowing across the cross-sectional area of the bore of the lamp.

Fig.12 Spectral outputs of gas filled pulsed lamps

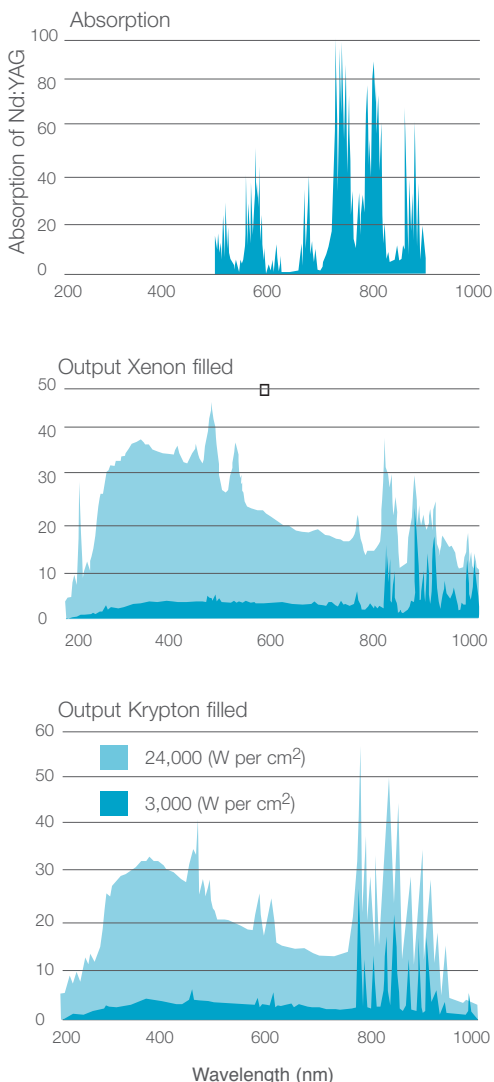



Gas fill and pressure continued

Fig.13 Variation of emission with cold fill pressure in pulsed lamps (4000W per cm²)

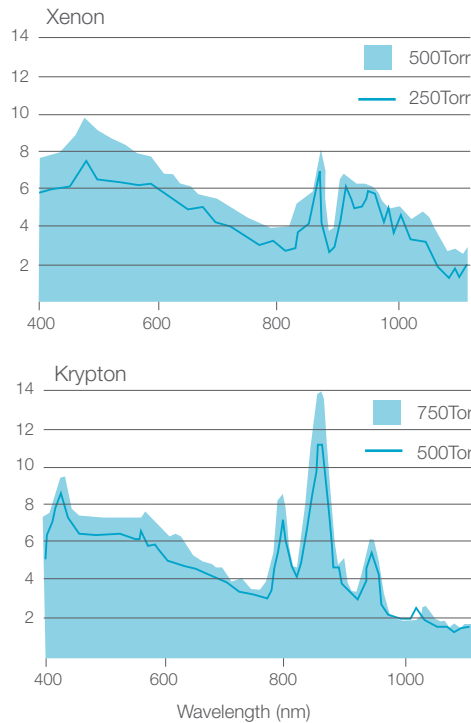

Current densities in such lamps are normally around 150 Acm⁻². Continuum radiation is also present in CW lamps but at an order of magnitude less than the useful pumping wavelengths.

Fill pressure is important because it largely determines the electrical operating characteristics of the lamp. With Heraeus Noblelight CW lamps, fill pressure is adjusted accurately to suit customer specification of operating voltage range and current.

Conversion efficiency increases with cold fill pressure, with a corresponding improvement in Nd:YAG pumping efficiency. As seen in figure 15, high power densities and high cold fill pressures yield the best results.

These optimised running conditions impose great stresses on the lamp and result in shortened lifetime. In practice fill pressures greater than 7500 Torr are rarely encountered. Cold fill pressures of Krypton filled CW lamps are usually in the range 3000 to 6000 Torr (4 to 8 atmospheres).

Lamp seals	6
Electrodes	7
Gas fill and pressure	10
Envelope materials	13
Lamp triggering	16
Continuous lamp operation	18
Pulsed lamp operation	21
Lamp cooling	28
Lamp finishing/terminations	30
Lamp lifetime	31
Glossary	34
Lamp coding	35
Lamp assembly	35
Lamp formulae	36
Conversion factors	37
Technical data sheet	39

The dominant radiation emission mechanism in Krypton filled CW lamps is through bound-bound transitions. This gives rise to a line spectrum in the infrared region (figure 14) which satisfactorily overlaps the absorption bands of Nd:YAG.

Fig.14 Spectral output of a standard Krypton CW lamp.

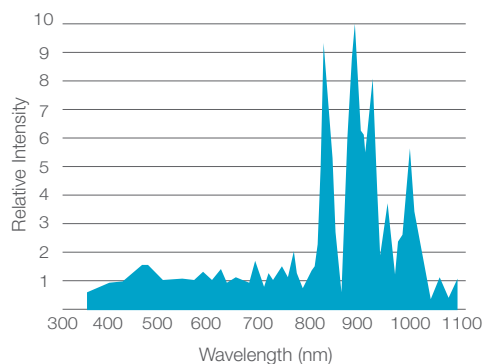
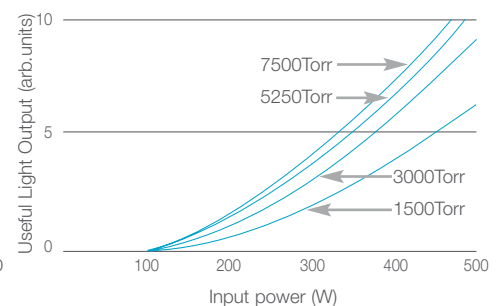

Fig.15 Useful light output as a function of input power at varying cold fill pressures



Envelope materials

The quartz body of a lamp, or fused silica envelope as it is more correctly known, surrounds the lamp and performs a vital function in holding the rare gas that forms the lamp arc.

This is no easy task. The material used cannot react with either the internal gas or the outside environment. It has to be strong enough to withstand the lamp's installation procedure, as well as the temperature and pressure extremes that the lamp will be subjected to during operation. In addition it should not restrict the lamp's light output, unless this is a specific requirement, in which case it must do so at the predefined wavelengths. Finally, the envelope material must be economical so as not to adversely affect the cost of the component.

It is possible to manufacture a lamp from borosilicate although this route is not often taken by designers. Borosilicate can only be used at low powers where the increase in envelope temperature during operation remains minimal, far lower than can be achieved with quartz. As there is no significant advantage of borosilicate over quartz in this application, and no real difference in the final product cost, there are few reasons for selecting borosilicate over quartz.

Quartz types

Heraeus Noblelight generally uses four different types of quartz. This quartz, supplied as tubes, is available in numerous bore diameters although the industry standard is whole one-millimetre increments with wall thicknesses of nominally either one millimetre or one half millimetre. When considering the wall thickness, thought should be given to the explosion energy and the maximum power as shown in figure 17.

Clear Fused Quartz (CFQ)

CFQ is the most commonly used and most economical form of quartz. If we assume fifty percent transmission to be the cut off line, the transmission range of CFQ is 200nm to 4250nm, as illustrated in figures 16 and 17. Care should be taken when using CFQ, as it transmits short wave ultra-violet (UV) light into the rest of the laser system. With this in mind other elements, for instance the laser rod, reflectors or plastic components, may need protection from UV damage.



Fig.16 Transmission characteristics of different envelope materials

Key

- A** Synthetic fused quartz (SFQ)
- B** Clear fused quartz (CFQ)
- C** UV absorbing Titanium doped quartz (TDQ)
- D** Borosilicate
- E** UV absorbing Cerium doped quartz (CDQ)

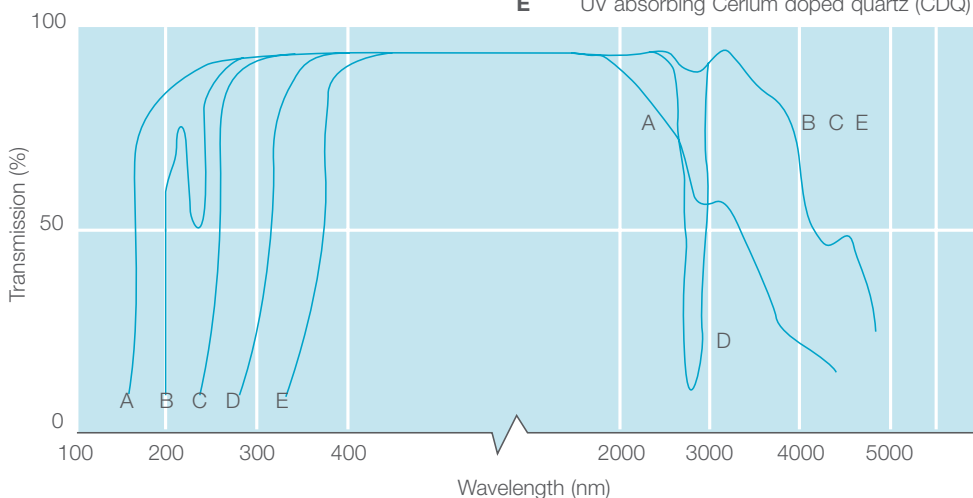



Envelope materials continued

In air-cooled applications there is often generation of Ozone (O_3), so adequate ventilation must be incorporated into the design. Another problem with CFQ is that it is prone to 'solarisation', especially in low power applications. Solarisation is the name given to a pale pink translucent discolouration that occurs in quartz because of colour centres, which occur as a result of Aluminium, Iron and Germanium ion impurities in the quartz.

Solarisation must be avoided, as it reduces the broad band light emission of the lamp, which ultimately reduces the laser's final output power, thus lowering the system's efficiency to below acceptable levels.

Cerium Doped Quartz (CDQ)

As the name suggests Cerium doped quartz is simply clear fused quartz with Cerium oxide doping. This small difference however, has far-reaching results. From figures 16 and 17 it can be seen that doping effectively cuts off the UV range of the emission spectrum. This halts the damage to other components in the cavity by light emitted at these wavelengths. In air cooled applications, it also prevents the production of Ozone, so outside ventilation is not required. Further, because the UV light is inhibited, there is minimal solarisation of the lamp envelope material. One final advantage of CDQ is that UV absorption is accompanied by fluorescence of the quartz in the visible spectrum. Some of this fluorescence falls into the absorption band of the laser rod, which leads to greater pumping efficiency.

Titanium Doped Quartz (TDQ)

As with CDQ, Titanium doped quartz is clear fused quartz but with Titanium oxide doping. From figures 16 and 17 it

is clear that TDQ does not limit UV wavelengths to the same extent as CDQ. It does not fluoresce, so the additional pumping efficiency is lost.

It is not surprising therefore that in the majority of applications, CDQ is used in preference. TDQ is, however, the quartz choice for many medical applications, solar simulation lamps and non-laser applications where ozone prevention is an issue.

Synthetic Fused Quartz (SFQ)

Synthetic quartz differs from the previous types mentioned in that it is made from synthetically produced silicon compounds such as Silicontetrachloride ($SiCl_4$). It is exceptionally pure and will transmit UV wavelengths to an even greater extent than the clear fused material. It also resists solarisation better than any other quartz and is used in applications including photochemistry, photolysis, fluorometry and spectrophotometry, where lower UV wavelengths are required.

As might be expected this quartz is the most expensive available.

Power calculations based on quartz type

When considering which type of quartz to use, care should be taken in calculating the power at which the lamp will be operated. Equations detailed in this book have been calculated with the assumption that the lamp has an envelope of one millimetre wall, clear fused quartz. Where a different wall thickness or quartz type is used, the final result of that equation should be multiplied by the percentages shown in figure 17.

Lamp seals	6
Electrodes	7
Gas fill and pressure	10
Envelope materials	13
Lamp triggering	16
Continuous lamp operation	18
Pulsed lamp operation	21
Lamp cooling	28
Lamp finishing/terminations	30
Lamp lifetime	31
Glossary	34
Lamp coding	35
Lamp assembly	35
Lamp formulae	36
Conversion factors	37
Technical data sheet	39

Tolerances

It should be remembered that the manufacture of quartz tube is a complex process. A large ingot of refined fused silica is heated and then force drawn to produce a tube. Because of this process, it is not possible to provide precise tolerances as standard. A typical piece of tubing will have a tolerance on both the internal and external dimensions of $\pm 0.3\text{mm}$. If necessary, the quartz can be hand-selected from Heraeus standard stock and the tolerance tightened, but this procedure relies on current stock levels and is not recommended.

Please ring Heraeus Noblelight to discuss specific requirements.



Fig.17 Envelope materials

Quartz type	Spectral range to 50% transmittance (nm)	Nominal wall thickness	Explosion energy calculation factor	Maximum average power calculation factor
Clear Fused Quartz (CFQ)	200 – 4250	0.5mm 1mm	-50% 100%	+60% 100%
Cerium Doped Quartz (CDQ)	360 – 4250	0.5mm 1mm	-57% -15%	+36% -15%
Titanium Doped Quartz (TDQ)	235 – 4250	0.5mm 1mm	-52% -5%	+52% -5%
Synthetic Quartz (SFQ)	160 – 4250	0.5mm 1mm	-50% 100%	+92% +120%



Lamp triggering

In general, arc lamps require a trigger pulse to cause the initial ionisation of the gas (the only exception is the rare case when pulse lamps are driven by applying a voltage higher than the self-breakdown voltage of the lamp).

This pulse is usually in the order of 20-30kV with a pulse width of a few microseconds. It is usually applied to the lamp using one of three methods - series, parallel or external triggering.

In the case of pulse lamps, a circuit without a simmer supply will require a lamp to be triggered for every pulse. In the case of simmered pulse and CW lamps, the trigger is only applied when the lamp is switched on.

It must be remembered that the cold fill pressure of the lamp has an effect on its triggering - high pressures require stronger trigger pulses.

Each lamp type will have a different trigger curve similar to the one shown in figure 18. However, even with careful quality control during manufacture, lamps of the same type - even from the same batch - will show variation from the expected curve. The scatter will be greatest at the extremes of lamp voltage, although generally trigger voltage should be at least 60% above that required to start most lamps of a given type.

In addition to having the correct trigger voltage, the relative polarity of the trigger and capacitor voltages should be observed, as shown in figure 19.

In the following descriptions, the circuit represents that of a PFN and pulse lamp, although the principles apply equally to square wave pulse and CW lamps.

Series triggering

The series technique uses a transformer in series with the lamp, thus the secondary winding has to be capable of handling the lamp current once triggering has taken place. Such transformers are expensive, although one key advantage of this method is that high voltages are not exposed on the lamp's exterior. Insulation and lamp changing problems are therefore simplified. Figure 20 shows a typical circuit.

The use of a ground plane greatly improves triggering and, in the case of air-cooled lamps, can take the form of a wire attached to one lamp terminal. In fluid-cooled applications, a metal laser cavity is often used as a suitable ground plane.

Often within a PFN set-up, the saturated inductance of the trigger transformer's secondary winding forms the inductance of a single LC network, thus removing the need for a second inductance.

Because of the high reliability factor of series triggering, it is the preferred method, particularly when using CW lamps.

Lamp seals	6
Electrodes	7
Gas fill and pressure	10
Envelope materials	13
Lamp triggering	16
Continuous lamp operation	18
Pulsed lamp operation	21
Lamp cooling	28
Lamp finishing/terminations	30
Lamp lifetime	31
Glossary	34
Lamp coding	35
Lamp assembly	35
Lamp formulae	36
Conversion factors	37
Technical data sheet	39

Fig.18 Typical flashlamp trigger curves

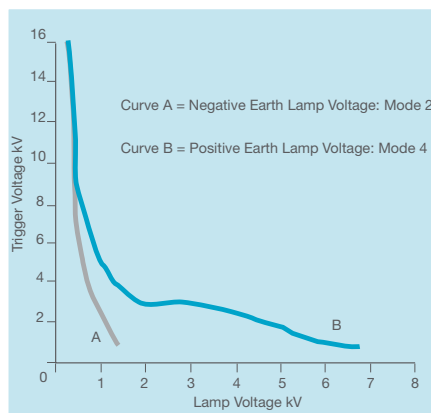

Parallel triggering

Figure 21 shows the parallel trigger technique which is similar to the series technique in that a high voltage spike is applied directly to one of the lamp electrodes. This method is rarely used however, because the cost of suitable protection components for the rest of the lamp circuit are prohibitively high.

External triggering

In this method, the triggering transformer is external to the lamp driving circuit. Lamp current does not flow through the secondary winding and thus external triggering transformers are relatively small and inexpensive.

In air-cooled applications, the high-voltage triggering pulse can be applied to the lamp via a nickel wire running the length of the lamp, usually with several loops around the lamp body.

In fluid-cooled applications, the pulse is sometimes applied to the metal laser cavity, however care should be taken because of the high voltages involved. A typical circuit can be seen in figure 22.

Heraeus Noblelight manufactures triggering transformers - please contact us for a data sheet with full information.



Fig.19 Lamp and trigger polarity conventions

Trigger mode	Common electrode	Power supply polarity	Trigger external	Polarity series
1	cathode	positive	positive	negative
2	cathode	positive	negative	positive
3	anode	negative	positive	negative
4	anode	negative	negative	positive

Fig.20 Typical series triggering circuit

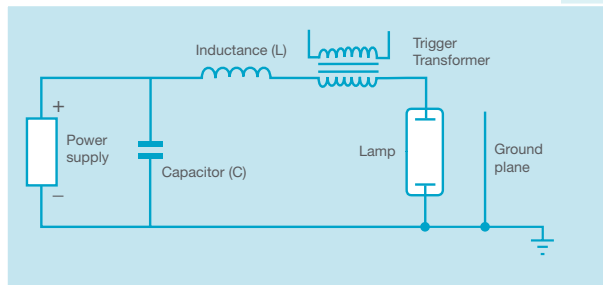

Fig.21 Typical parallel triggering circuit

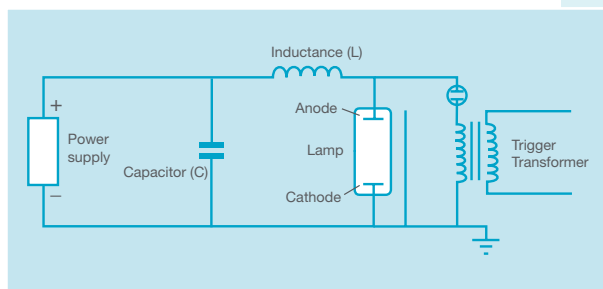
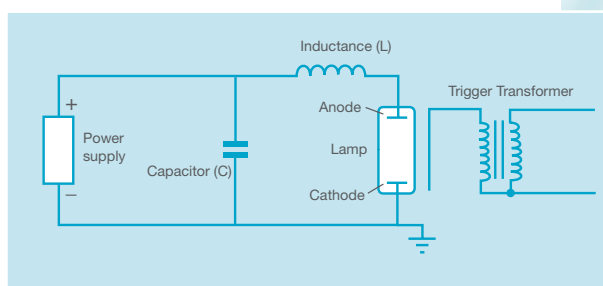

Fig.22 Typical external triggering circuit





Continuous lamp operation

Continuous Wave (CW) lamp operation

As with many other gas discharge devices, the CW lamp has a complex voltage/current characteristic as shown in figure 23. Immediately on breakdown the device has a negative slope impedance, and the voltage drops to a minimum at about 1-5 amps. The exact current at the minimum point depends very much on the detailed nature of the lamp. The applied voltage then increases with current past this minimum as the working region of the lamp is approached.

Transition to the working region of the lamp

The negative impedance characteristic at the start of the lamp breakdown produces an interesting problem in system design.

In figure 24, the line AB shows the typical load line of the power supply. This intersects the VI characteristic of the lamp at two points, one at the negative slope side and the other at the working point on the positive slope side. If the energy contained within the trigger pulse is not sufficient for the lamp to reach the first of these intersection points, the main power supply will not provide enough energy for the trigger streamer to grow, and for the lamp to move to the stable operating point E.

The provision of a main power supply to the first intersection, where the lamp is driven by the trigger pulse, is generally uneconomic (it requires a much higher voltage than is needed for running). The usual solution is to have a boost power supply with the load line indicated by the line XY. As it is only required at start up, the supply can be fairly low cost. Usually a small low current power supply charges up a capacitor; the capacitor acting as a very short duration power supply.

The sequence of operations for breaking the lamp down and getting into the running region is as follows.

At switch-on, the capacitor for the boost supply is charged up; the smoothing capacitors in the main power supply are also charged. The trigger circuit then gives a fast pulse in the order of 20-30 kilovolts, with currents of the order of an amp and with timescales of one or more microseconds width. This causes initial conduction, allowing the boost supply to begin to pass current through the lamp. The boost supply typically works with a voltage of around a kilovolt, a time constant of 2 to 3 milliseconds, and currents of 10 amps or so.

The final stage is when the main power supply takes over and gives the normal running parameters of the lamp.

Lamp seals	6
Electrodes	7
Gas fill and pressure	10
Envelope materials	13
Lamp triggering	16
Continuous lamp operation	18
Pulsed lamp operation	21
Lamp cooling	28
Lamp finishing/terminations	30
Lamp lifetime	31
Glossary	34
Lamp coding	35
Lamp assembly	35
Lamp formulae	36
Conversion factors	37
Technical data sheet	39

Fig.23 Voltage/current characteristic, CW lamp

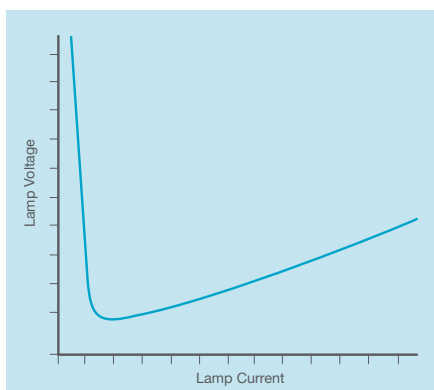
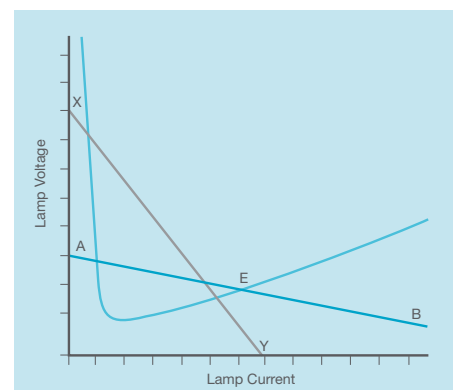

Fig.24 Load lines of main and boost power supply



Quasi-CW and modulated CW operation

Despite their name, CW lamps are not limited to continuous wave operation. There are two other modes of operation which are increasingly being used.

Quasi-CW

'Quasi-CW' is the name given to the operation of a CW lamp where the output forms a sinusoidal waveform, usually either 50 or 100 Hertz. This frequency is, in theory, infinitely variable but the cost of the power supply is greatly reduced if the frequency is a whole multiple of the local electricity supply. Quasi-CW operation is shown in figure 25.

In order to maximise the lamp lifetime, it is important that when this waveform is applied, the total power limitations of the lamp are not exceeded. The distance between the peak of the current curve and the centre line representing nominal current is known as the depth of modulation and should not exceed fifty percent of that value.

Modulated CW

In this method of operation the lamp's output waveform is switched between two different levels leading to a columnar waveform. The upper level is normally the nominal current of the lamp, whilst the lower level should not be below the minimum recommended current. On and off times are typically in the region of a few seconds. For example, a six-millimetre bore lamp could be modulated between thirteen and forty amps. Again, in order to maximise lamp life, it is important that the average power is not exceeded. Modulated CW operation is shown in figure 26.

CW lamp design parameters

When designing a CW lamp, lifetime will be optimised by careful reference to the parameters in figures 27 and 28.

For requirements outside of the recommended parameters, please contact Heraeus Noblelight who can advise on custom design.

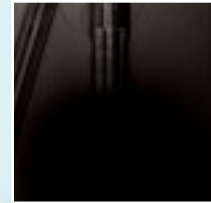

Fig.25 Quasi-CW operation

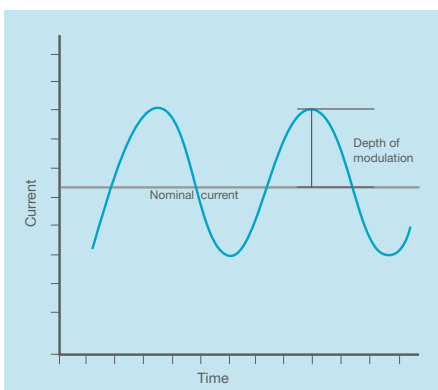
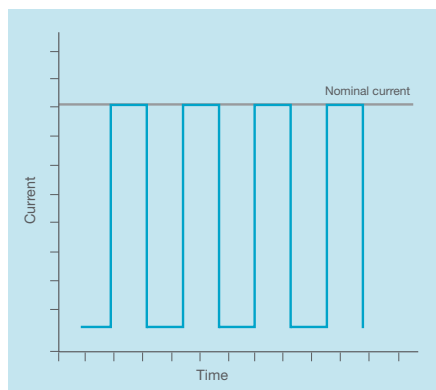

Fig.26 Modulated CW operation





Continuous lamp operation continued

Fig.27 CW lamp recommended physical dimensions

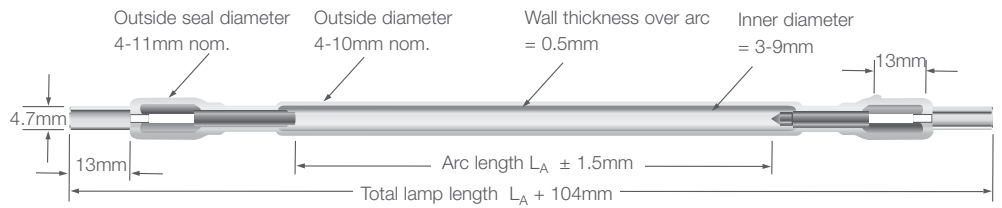

Fig.28 CW lamp electrical parameters

Bore (mm)	Rec. maximum loading Watts/cm	Nominal current A	Rec. maximum current A	Rec. minimum current A	Max. static impedance at nominal current Ω/cm	Max. dynamic impedance at nominal current Ω/cm
3	300	10	13	5	1.70	0.586
4	400	20	24	7	1.10	0.379
5	520	30	33	10	0.60	0.207
6	700	40	46	13	0.41	0.141
7	800	50	56	17	0.31	0.107
8	900	65	73	22	0.25	0.086
9	1000	80	89	30	0.21	0.072

Lamp seals	6
Electrodes	7
Gas fill and pressure	10
Envelope materials	13
Lamp triggering	16
Continuous lamp operation	18
Pulsed lamp operation	21
Lamp cooling	28
Lamp finishing/terminations	30
Lamp lifetime	31
Glossary	34
Lamp coding	35
Lamp assembly	35
Lamp formulae	36
Conversion factors	37
Technical data sheet	39

Pulsed lamp operation

Pulsed laser lamps are primarily operated in one of two distinct modes – Pulse Forming Network (PFN) or Square Wave (also known as high charge or switched mode pulsed). Although square wave power supplies are increasingly being used to drive pulsed laser lamps, the physical phenomena in pulsed lamps - driven by either circuit type - are essentially identical.

Obviously, calculations that involve the time constants of pulse forming networks are not applicable to switched mode power supplies, but considerations of the effects of pulse energy and pulse width on lifetime are the same for both types of driving circuit.

Pulse forming network operation

Driving circuit

The basic pulsed lamp driving circuit is shown in figure 29 (ignoring circuit resistances and inductances for the sake of simplicity).

When the lamp is non-ionised it has a very high impedance - around 10^7 ohm or more - and thus initially, all the power supply unit current flows into capacitor C. If the voltage across the capacitor reaches a value equal to the self-breakdown voltage of the lamp, ionisation of the lamp gas starts to occur and so its impedance begins to fall. A low impedance path quickly forms between the electrodes of the lamp as more gas atoms are ionised. Current now flows from the capacitor into the lamp and the impedance of the lamp continues to fall, dropping down to about 1 ohm or less. If sufficient charge is available, the plasma of ionised gas in the lamp completely fills the bore. Eventually all the energy stored in the capacitor is expended and the lamp returns to a de-ionised state. Conduction through the lamp ceases and

the power supply unit begins to recharge the capacitor and thus the process continues.

The resultant current waveform under this type of operation is essentially sinusoidal in the positive region.

There are three distinct regimes in the operation of a lamp:

- a Initial arc formation - or 'triggering' (see Triggering section, page 16)
- b Unconfined discharge regime of the plasma
- c Confined (wall-stabilised) discharge regime of the plasma.

Unconfined discharge regime of the Plasma

Once triggering has taken place, the plasma grows. Current through the lamp increases rapidly and the voltage drop across the lamp falls rapidly. As a result, the lamp's impedance decreases. During this stage (some 20% of the rise time of the current pulse through the lamp), the characteristics of the arc are not influenced by the inner wall - ie the discharge is unconfined. If sufficient energy is available, the plasma grows until it fills the bore of the lamp and becomes what is termed 'wall stabilised'.

Confined (wall-stabilised) discharge regime of the Plasma

When the arc reaches this stage, it is characterised by high current and high



Fig.29 Simple pulsed lamp driving circuit

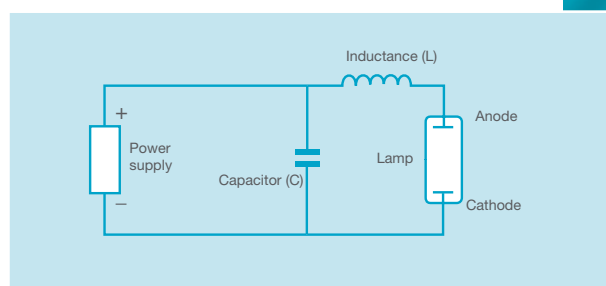



Pulsed Lamp operation continued

power density, and can be described as having an impedance with the following relationship to time:

EQUATION A

$$K_0[t] = |V(t) [I(t)]^{-1/2}|$$

V(t) = voltage across the lamp at time t, in volts
 I(t) = current through the lamp at time t, in amps
 K₀[t] = arc impedance parameter at time t, in ΩA^{1/2}
 K₀[t] is a function of the time-dependent size of the arc and the nature and fill pressure of the gas in the lamp.

EQUATION B

$$K_0[t] = \frac{1.28L_A}{d_A(t)} \times \left(\frac{P}{N}\right)^{-1/5}$$

L_A = arc length, in mm
 d_A(t) = arc diameter at time t, in mm
 P = gas fill pressure in the lamp, in Torr
 N = a constant dependent on gas type (Xenon 450; Krypton 805)

A good approximation can be reached (avoiding dealing with the time dependent equations A and B which require computing techniques), by assuming that the diameter of the arc is always equal to the diameter of the bore of the lamp (d) - (ie by assuming that d_A(t) is not time dependent). In general the time taken to reach stabilisation is less than one-hundredth of the pulse width.

Thus, equation B becomes:

EQUATION C

$$K_0 = 1.28 \frac{L_A}{d} \times \left(\frac{P}{N}\right)^{-1/5}$$

K₀ can now be referred to as the impedance constant of the lamp. This is constant for any given lamp because K₀ depends only upon the lamp's physical dimensions and the type and pressure of gas fill. K₀ is a critical parameter in describing a pulsed lamp.

EQUATION D

$$V(t) = \pm K_0 [I(t)]^{1/2}$$

In practice, pulsed lamps are often driven by a single-stage inductance-capacitance (LC) network as shown in figure 29. The equations describing this network are:

EQUATION E

$$E_0 = \frac{CV_0^2}{2}$$

EQUATION F

$$t = (LC)^{1/2}$$

EQUATION G

$$C = \left(\frac{2E_0 \alpha^4 t^2}{K_0^4}\right)^{1/3}$$

EQUATION H

$$Z_0 = \left(\frac{L}{C}\right)^{1/2}$$

EQUATION I

$$T = 3t$$

E₀ = energy stored in capacitor C, in Joules
 C = capacitance of capacitor C, in Farads
 L = inductance in Henries
 V₀ = initial voltage across capacitor, in volts
 t = time constant of circuit, in seconds
 Z₀ = impedance of circuit, in ohms
 T = pulse length in seconds (at 1/3 peak height)
 α = damping coefficient.

Solving these equations for I(t) with different values of α, the family of curves shown in figure 31 can be created. For value α = 0.8, as can be seen there is no reversal of the current in the circuit. This is known as a critically damped circuit in which the pulse length T is defined as 3t. In practice, the laser pulse length would be shorter than the value T.

Lamp seals	6
Electrodes	7
Gas fill and pressure	10
Envelope materials	13
Lamp triggering	16
Continuous lamp operation	18
Pulsed lamp operation	21
Lamp cooling	28
Lamp finishing/terminations	30
Lamp lifetime	31
Glossary	34
Lamp coding	35
Lamp assembly	35
Lamp formulae	36
Conversion factors	37
Technical data sheet	39



By the use of equations C and E to G, a lamp and circuit can be chosen which satisfies the requirements of any given application. The user would normally specify the pulse energy and pulse width, while K_0 can be approximated using equation C. α is usually chosen as 0.8, but values between 0.6 and 1.0 are acceptable. The required values of C, L and V_0 can thus be determined.

From this analysis it can be seen that for a given pulsed lamp and a specified pulse energy and width, there is only one value each for C, L and V_0 that will result in critical damping - a requirement for maximum efficiency and lamp life.

Current curves

An approximate value of peak current can be calculated from:

EQUATION J

$$I_{\max} = \frac{V_0}{Z_0 + Z_L}$$

Z_L is the impedance of the lamp in ohms.

This can be derived from:

EQUATION K

$$Z_L = \frac{\rho L_A}{\text{Cross-sectional area of lamp}} = \frac{4 \rho L_A}{\pi d^2}$$

ρ = resistivity of plasma (ohms cm)

ρ can be quantified from figure 30:

The average input power to a pulsed lamp is given by:

EQUATION L

$$\text{Average Power} = E_0 \times f$$

f is the pulse repetition rate in Hertz

Fig.30 Plasma resistivity

ρ	t
0.015	$\leq 100\mu\text{s}$
0.020	$>100 \leq 1000\mu\text{s}$
0.025	$>1000\mu\text{s}$

EXAMPLE:

Pulse energy required = 500 Joules

Pulse width required = 1 ms = $1 \times 10^{-3}\text{s}$

Consider the use of a 6*102XFP lamp.

K_0 can be calculated from equation C using:

$L_A = 102\text{mm}$

$d = 6\text{mm}$

$P = 450\text{ Torr (default fill pressure for Xenon)}$

$N = 450\text{ (Xenon fill)}$

therefore:

$$K_0 = 1.28 \times \frac{102}{6} \left(\frac{450}{450} \right)^{1/5}$$

= 21.76 $\Omega A^{1/2}$

We require a critically damped pulse, therefore $\alpha = 0.8$

Fig.31 Current curves for different values of α .

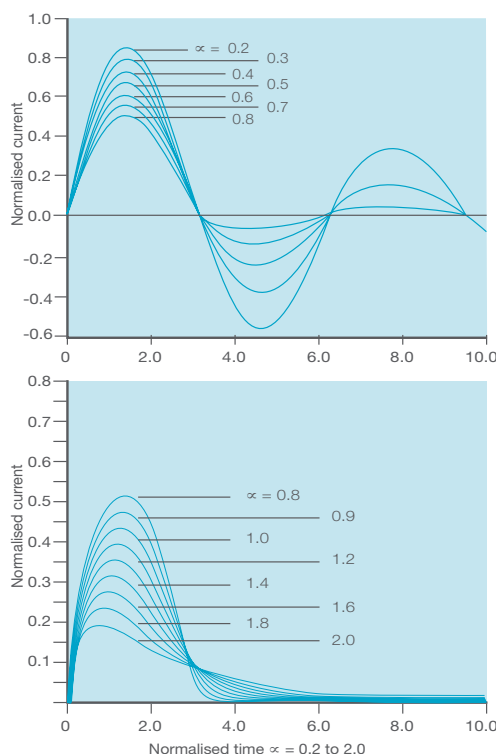



Pulsed lamp operation continued

The values of the circuit components required to run the lamp in the way specified may now be calculated:

From equation G:

$$C = \left(\frac{2 \times 500 \times (0.8)^4 \times (3.3 \times 10^{-4})^2}{(21.76)^4} \right)^{1/3}$$

$$= 0.585 \times 10^{-3} \text{ Farad}$$

$$= 585 \mu\text{F}$$

[equation I gives t as T/3 = 0.33 x 10⁻³

From equation F:

$$L = \frac{(0.33 \times 10^{-3})^2}{585 \times 10^{-6}}$$

$$= 186 \times 10^{-6} \text{ Henries}$$

$$= 186 \mu\text{H}$$

From equation E:

$$V_O = \left(\frac{2 E_O}{C} \right) = \left(\frac{2 \times 500}{585 \times 10^{-6}} \right) = 1300\text{V}$$

Deviations from theory

An assumption in the above description is that the plasma makes contact with the inner wall area of the lamp at an early stage in the current pulse. This is unlikely to be true in reality and the following deviations from theory apply:

- a** Peak pulse currents will be slightly lower
- b** Critical damping occurs at a lower value of α
- c** Current reversal is less when α is lower than 0.8.

Nevertheless, the approximations assumed allow for simple (and in most cases accurate) calculations and predictions to be made. It should also be noted that multiple section LC circuits can be used to drive pulsed lamps. Such circuits can provide semi-rectangular current waveforms.

Square Wave power supply operation

In systems using square wave power supplies, the Laser Designer is primarily concerned with the K_O of the laser lamp, as this determines the lamp's power output and hence the power of the laser itself. Heraeus Noblelight has considerable experience in optimising pulsed lamps to state-of-the-art driving systems. The company has built its own power supply equipment for Research and Development into high charge transfer lamps, and for the testing of every lamp that leaves the factory.

Square Wave operation of a pulse lamp provides a very different current waveform compared with that generated by the PFN above. Square Wave operation is essentially generated by switching the stored voltage in a capacitor bank directly through the lamp using fast-acting electronic switches. The height of the pulse is similarly controlled. The fast rise times and controlled current height result in a basic square wave.

Simmer operation

Fast rise times are possible because the lamp is kept in a state of ionisation with a low-level dc current. One advantage of this is that a lamp is only required to be triggered once when switched on. After triggering, a low-level dc discharge (also known as a 'simmer') is maintained through the lamp. Typically this is 50-1000 mA, and figure 32 shows the recommended and maximum simmer currents for various lamp bore sizes.

Figure 34 shows the typical voltage per millimetre of arc at a given current. These values assume a gas fill of 450Torr Xenon or 700Torr Krypton. Increased fill pressures will give rise to higher voltages.

Lamp seals	6
Electrodes	7
Gas fill and pressure	10
Envelope materials	13
Lamp triggering	16
Continuous lamp operation	18
Pulsed lamp operation	21
Lamp cooling	28
Lamp finishing/terminations	30
Lamp lifetime	31
Glossary	34
Lamp coding	35
Lamp assembly	35
Lamp formulae	36
Conversion factors	37
Technical data sheet	39

Simmer mode operation generally extends lamp lifetime and is often used in high power, high repetition rate applications, including most industrial solid state laser systems. Simmer current and voltage must be in the correct region of the lamp VI curve if stable simmering is to be achieved. Simmer also offers higher laser pumping efficiency up to 20% at low current densities. This advantage disappears at high current densities. Another benefit is improved pulse to pulse optical output stability.

Currents below the recommended values are likely to give rise to instability and possible simmer extinction, particularly with high energy, low frequency pulses. High open-circuit simmer voltage is necessary to help initiate the simmer streamer and sustain it between pulses. The required open-circuit voltage is dependent on lamp geometry and fill pressure, but one general recommendation is that it should be no less than 1000V.

Triggering

As mentioned in the Triggering section (page16), lamp triggering occurs only when the system is switched on and the lamp is struck into simmer mode. The trigger pulse required is the same as that for PFN systems (20 to 30kV in the microsecond range), and can be applied either in series or external configuration.

Driving circuit

Utilising a power supply, charging capacitor, electronic switch, simmer supply and trigger transformer, a typical driving circuit is shown in figure 33.

The electronic switch is typically either an SCR or IGBT.

There are further enhancements to be considered, such as snubber components, normally required to protect the electronic switch. As the control electronic switch handles high peak and RMS currents, it must be selected with care. Delay circuitry is also usually needed in the capacitor charging supply, to allow the electronic switch to turn off fully following lamp pulsing.

The approximation for K_0 based on bore diameter, arc length, gas type and cold fill pressure (equation C) still remains for lamps used under square wave pulse operation.

As we are dealing with a square wave in terms of both lamp current and lamp voltage, and the discharge is fully wall-stabilised, reference to the timing within the pulse is no longer relevant, as it is the same at all stages during the wall-stabilised pulse. This simplifies some of the theory, and the relationship between voltage, current and K_0 previously described by equation D can now be



Fig.32 Recommended and maximum simmer currents

Bore size mm	Recommended current	Maximum recommended current
3-4	100mA	300mA
5-6	200-300mA	1A
7-8	500-1000mA	4A
9-13	1-2A	4A

Fig.33 A basic drive circuit for square wave pulsing

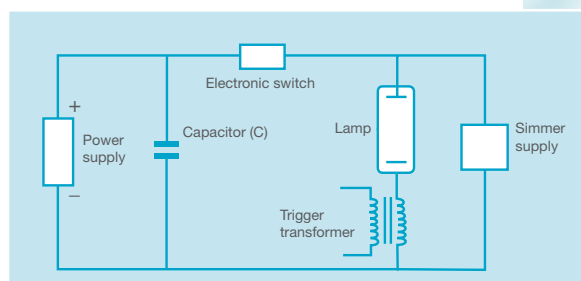



Pulsed lamp operation continued

expressed as:

EQUATION M

$$V = K_0 I^{1/2}$$

Calculations of pulse power and pulse energy also become more simple:

EQUATION N

$$\text{Pulse power} = K_0 I^{3/2}$$

EQUATION O

$$I = \left(\frac{E_0}{K_0 T} \right)^{2/3}$$

T is the pulse width in seconds.

Average power can still be calculated using equation L, or by using:

EQUATION P

$$\text{Avg Power} = \text{Pulse Power} \times T \times f$$

To calculate voltage and current if pulse energy, K_0 and pulse width are known:

EQUATION Q

$$E_0 = \frac{V^3 T}{K_0^2}$$

Equation M should then be used to determine the pulse current.

Example:

Pulse energy required = 500 Joules
Pulse width required = 5 ms = 5×10^{-3} s

Frequency = 10 Hertz

Consider the use of a 6*150KFP lamp.

K_0 can be calculated from equation C using:

$L_A = 150$ mm

$d = 6$ mm

$P = 700$ Torr (default fill pressure for Krypton)

$N = 805$ (Krypton fill)

therefore:

$$K_0 = 1.28 \times \frac{150}{6} \left(\frac{700}{805} \right)^{1/5}$$

= 31.12 ohms (amps)^{1/2}

From equation Q:

$$I = \left(\frac{500}{31.12 \times 5 \times 10^{-3}} \right)^{2/3} = 218 \text{ A}$$

From equation M:

$$V = 31.12 \times 218^{1/2} = 460 \text{ V}$$

From equation N:

$$\begin{aligned} \text{Pulse power} &= 31.12 \times 218^{3/2} = 100166 \text{ W} \\ &= 100.2 \text{ kW} \end{aligned}$$

From equation P:

$$\begin{aligned} \text{Average power} &= 100166 \times 5 \times 10^{-3} \times 10 \\ &= 5000 \text{ W} = 5 \text{ kW}. \end{aligned}$$

Lamp seals	6
Electrodes	7
Gas fill and pressure	10
Envelope materials	13
Lamp triggering	16
Continuous lamp operation	18
Pulsed lamp operation	21
Lamp cooling	28
Lamp finishing/terminations	30
Lamp lifetime	31
Glossary	34
Lamp coding	35
Lamp assembly	35
Lamp formulae	36
Conversion factors	37
Technical data sheet	39

Fig.34 Generalised simmer curve

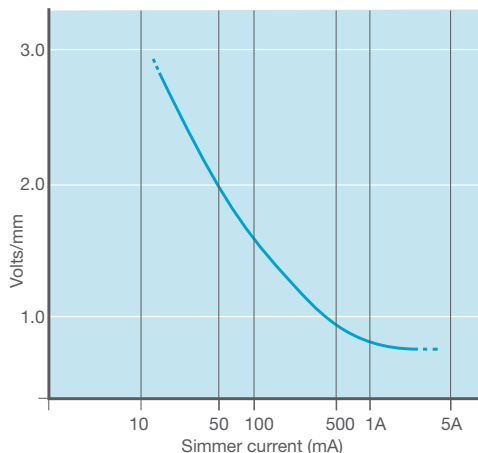



The Heraeus Noblelight patented Hi-Charge™ lamp series is specifically designed for use under these square wave pulse conditions and incorporates an area of reduced diameter behind the tip of the cathode. This restricts the flow of heat back down the body of the electrode thus maintaining the temperature of the cathode tip to within a much tighter band.

The thermal cycling of the cathode tip is thus minimised, leading to improved lamp lifetime.

Pulse lamp design parameters

When designing a pulse lamp, lifetime will be optimised by careful reference to the parameters in figures 35, 36 and 37.

For specifications outside the recommended parameters, please contact Heraeus Noblelight who can advise on customised requirements.

Fig.35 Pulse lamp operation

Bore	K_0 /mm		K_{ex} /mm	Max.recommended power/mm		
	Xe	Kr		Convection	Forced	Fluid
3	0.426	0.415	736	1.41	2.82	18.85
4	0.320	0.311	984	1.89	3.77	25.13
5	0.256	0.249	1230	2.35	4.71	31.41
6	0.213	0.207	1476	2.82	5.65	37.69
7	0.182	0.177	1719	3.29	6.59	43.98
8	0.160	0.155	1968	3.76	7.53	50.26
9	0.142	0.138	2217	4.24	8.48	56.55
10	0.128	0.124	2467	4.71	9.42	62.83
11	0.116	0.113	2717	5.18	10.36	69.11
12	0.106	0.103	2970	5.65	11.30	76.39
13	0.098	0.095	3199	6.12	12.25	81.68

Fig.36 Fluid-cooled pulse lamp recommended physical dimensions (mm)

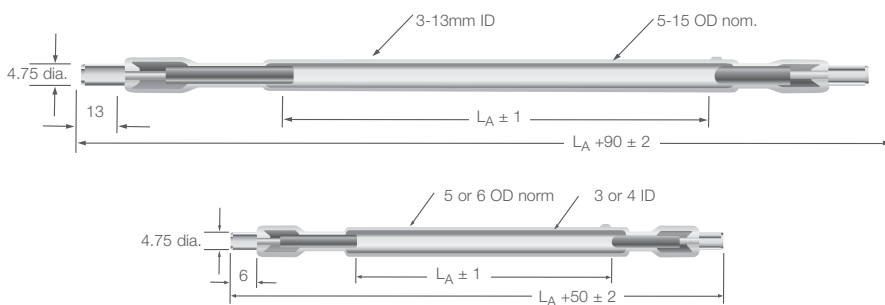
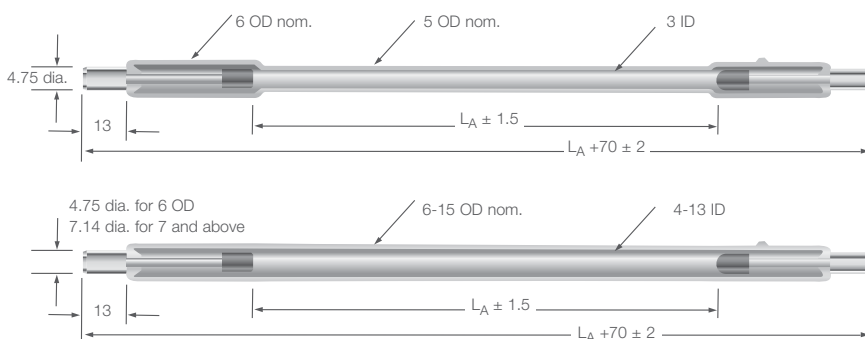

Fig.37 Air-cooled pulse lamp recommended physical dimensions (mm)





Lamp cooling

Adequate cooling ensures that lifetime is optimised by preventing the inside wall of the lamp envelope from overheating.

Contributory factors to heating are the use of UV-absorbing envelope materials, thick-walled envelopes, low fill pressures and Krypton gas fill (rather than Xenon). As some pulsed lamps operate at such high average power densities - up to 200Wcm^{-2} - cooling liquid with turbulent flow around the lamp is necessary. Failure to cool flashlamps adequately will result in unreliable operation and shortened lifetimes.

Most commercial pulsed solid state lasers and all continuous lamp pumped solid state lasers require fluid cooling. This is normally achieved by flowing demineralised water over the lamp by use of a flow tube or flow plate. All envelope materials have a maximum power loading which is usually expressed in Wcm^{-2} . This maximum not only depends on whether it is convection, forced-air or liquid cooled, but also on the type of quartz used. Figure 17 on page 15 details the de-rating values for common envelope materials.

The cooling requirement for flashlamps and continuous lamps used for laser applications is well defined. To determine the method necessary for correct lamp cooling, divide the average input power in watts by the internal wall area (cm^2) of the arc region. The resulting quotient is in watts per cm^2 (Wcm^{-2}). This value should then be used to determine the cooling method required as illustrated in figure 38.

The loadings in figure 38 assume Xenon gas fill. Due to higher internal wall temperatures, de-rate by 10% for Krypton.

Convection air cooling

Lamps operated at low input energies and at low flash rates seldom require special cooling considerations, as heat from the lamp envelope and electrodes is lost by radiation. As the input power and the flash rate are increased, there comes a point when some method of accelerating heat removal from the lamp must be considered.

Forced air cooling

When forced-air cooling flashlamps, the air flow should extend to the ends of the lamp and include the seals and connectors. Forced-air cooling is rare in solid state laser pumping applications.

Forced air cooling can be achieved by simply blowing air onto the lamp using a fan. While this method increases the cooling of the lamp, allowing higher power densities, care must be taken to distribute the cooling as uniformly as possible over the lamp envelope. To avoid contamination on the outer surface of the lamp, it is recommended that the air flow is filtered.

Fluid cooling

As mentioned previously, fluid cooling is achieved by the use of a flow tube around the lamp. 'Pockets' of boiling fluid must be avoided and the flow should encompass the entire arc length and the anode area.

Fig.38 Lamp cooling requirements

Wall loading	Min. cooling requirement
< 15 Wcm^{-2}	Convection air cooling
15 – 30 Wcm^{-2}	Forced air cooling
30 – 200 Wcm^{-2}	Fluid cooling

Lamp seals	6
Electrodes	7
Gas fill and pressure	10
Envelope materials	13
Lamp triggering	16
Continuous lamp operation	18
Pulsed lamp operation	21
Lamp cooling	28
Lamp finishing/terminations	30
Lamp lifetime	31
Glossary	34
Lamp coding	35
Lamp assembly	35
Lamp formulae	36
Conversion factors	37
Technical data sheet	39

For liquid cooling, demineralised water has been found the most suitable and should have a resistivity of 200kΩm or greater.

High conductivity water should be avoided.

In situations where the lamp connectors are immersed in the coolant, the effect of the boost and trigger voltages can be reduced, leading to unreliable lamp operation.

Electrolysis of the connectors can also occur, resulting in deposits on the lamp envelope, reducing light output and lifetime.

The annulus between lamp and flow tube should be 1–2mm. The flow should be turbulent, and at a minimum rate of 1.5 litres per minute per kilowatt. Because the anode operates at a higher temperature than the cathode, the direction of flow should be from anode to cathode. The velocity of the water under these conditions should be a minimum of 4 ms^{-1} . The temperature increase in the water should be approximately 10°C over the length of the lamp.

In order to maintain the purity of the cooling water, only stainless steel and plastic components should be used in the water circuit.

If quartz wall thicknesses are greater than 0.5mm, or if envelopes of doped materials are involved, then higher flow rates may be required. They may also be required if power densities higher than 200 Wcm^{-2} are generated.

In fluid-cooled applications with adequate cooling of electrodes, the quoted permissible wall loadings are often exceeded by large margins. Conversely, as these loadings are for new lamps, they will require de-rating as the lamp ages, or a safety margin built in to allow for absorption due to sputtered deposits from electrodes or solarisation.





Fig.40 Lamp finishings and terminations

Finishing and terminations

Figure 40 shows a general view of the majority of lamp finishing and terminations used within the industry. Heraeus Noblelight also makes custom terminations and finishing to suit individual customer requirements.

The geometry of this sleeve is dictated by individual customer requirements.

Positioning

Base connectors made of Nickel-plated Copper can be fitted slightly offset from the lamp dome. This not only allows the lamp envelope to expand slightly during operation, but also enables the coolant to circulate freely across the dome surface, providing increased cooling. This is particularly relevant to high energy pulsed lamps. For the same reasons, PEI sleeves are also fitted in an offset position.

Materials

In general, metal connectors of the base style are made in two different materials. Stainless steel tends to be used on CW lamps, whilst Nickel-plated Copper tends to be used on pulsed lamps because of its lower resistance to high current pulses. Custom materials can be used if required.

Lamp mounting

As a variation, base connectors are also available in industry-standard styles typically used in such systems as those made by Osram, Lasag, Lumonics, etc.

When making electrical connections to a lamp, there are three important points to be considered:

Flying lead terminations are generally of two types, twisted wire or braided wire. Either of these can be supplied in a variety of core and plating materials. Similarly, either can be supplied bare or insulated, and insulation can be supplied in a variety of materials to suit individual requirements in terms of flexibility, temperature resistance etc, see figure 39. If required, the lamp ends can be left unfinished as plain Tungsten wire, supplied either bare or nickel-plated.

- a** The lamp should not be held rigidly. Graded seals are liable to fracture if subjected to undue stress. These stresses can be avoided by mounting a lamp in o-rings or sprung connections.
- b** The electrical connection should offer a large area of direct contact to the lamp termination. Small contact areas and dirty connections can generate localised resistive heating, resulting in corrosion.
- c** High temperatures can be encountered in operation.

In all cases, a sleeve of Polyetherimide (PEI) – a high-quality engineering plastic with excellent UV and temperature resistance – can be fitted to allow o-ring mountings away from the lamp surface.

Liquid cooling of at least part of the termination is therefore recommended, with demineralised and de-ionised water.

Care should be taken when designing o-ring seals seating on the quartz envelope of the lamp, as it is difficult to maintain tight engineering tolerances.

Fig.39 Wire insulation properties

Factor	Unit	PTFE	PVC	Silicone Rubber
UV resistance	-	Excellent	Good	Good
Dielectric strength	kVmm ⁻¹	50-170	14	29
Volume resistivity	Ωm	10 ¹⁸ -10 ¹⁹	10 ¹⁶	10 ¹³
Upper working temp.	°C	180-260	50-75	200-300
Flexibility		Poor	Good	Excellent

Trigger wires

Trigger wires for air-cooled applications can be fitted according to individual requirements. Generally, these are made from Nickel or Nickel-Chromium wire, but other materials can be used if preferred.

Lamp lifetime

Lamp lifetime, also known as ageing, is a complex subject. It is closely related both to the lamp's application and the environment in which it is used. Further, flash lamps and DC arc lamps are not generally operated under standardised conditions, hence manufacturers cannot give specific time values for lamp life. Instead, flash lamp lifetime is normally measured in terms of the total number of shots or flashes achieved to the point where the useful light output drops to some arbitrary intensity. Having said this CW Krypton arc lamps usually have their lifetime measured in the total number of hours of operation, as the shot value obviously cannot be calculated.

The definition of 'end of life' will vary from customer to customer. Take for example a DC arc lamp operating in a system where the application requires maximum laser output power. The lamp may need to be removed after 400 hours if no further adjustment in lamp input power is available and the laser output power required for the application can no longer be achieved. But the same lamp could be installed into a second system where the application requires an entirely different set of parameters and the final lifetime figure would be completely different.

Design aspects of the pump chamber - such as degree of close coupling, coolant flow rates, coolant velocities etc - may also vary between systems, which could enable the lamp to perform satisfactorily for a much longer period.

Failure mechanisms

Generally speaking there are four major reasons for lamp failure.

- 1 *Electrode erosion*, which leads to deposition of material on the inside wall of the envelope, and in turn to a

reduction in the useful light output from the plasma.

- 2 *Contamination of the fill gas* leads to misfiring, ignition failure or simmer difficulty.
- 3 *Cracked glass to metal seals*
- 4 *Explosion*, due to ablation, devitrification or cracking of the quartz envelope.

Electrode erosion

Electrode erosion in flash lamps predominantly occurs at the cathode, particularly under conditions where the charge transfer per pulse is high. In this situation, the cathode tip is subjected to severe thermal stresses. The effect of this constant thermal cycling causes the surface of the cathode to fracture and eventually, relatively large metallic particles will detach from the cathode and be ejected into the arc region.

Erosion of this nature will result in a reduction in light output and, potentially, failure of the quartz envelope.

The majority of modern day flash lamps and DC arc lamps contain dispenser cathodes. These cathodes are impregnated with low work function Barium-based compounds, designed to promote efficient emission of electrons during lamp operation. Due to the alkaline nature of these compounds however, a chemical reaction occurs with the quartz glass in the arc region at elevated temperatures. Devitrification of the quartz and cracks in the internal surface of the tube will ensue, eventually leading to breakage of the quartz envelope.

The Heraeus Noblelight patented Hi-Charge™ series lamps have been specifically developed to minimise this effect for high charge transfer operating conditions.





Lamp lifetime continued

In a well-designed cavity and flash lamp arrangement, deterioration of the anode is seldom a problem, providing the design allows for adequate cooling and the operating parameters do not deliver excessive peak or average powers to the anode.

In DC arc lamps however, the power loading at the anode is considerably higher than in flash lamps. This means much higher temperatures are achieved and thus the sputtering or evaporation process from the anode is accelerated. The high gas fill pressure associated with these types of lamps does have an inhibiting effect on the build up of deposits, restricting them to a region in close proximity to the electrode.

Electrode deterioration can be controlled to some degree by the lamp manufacturers through careful selection of raw materials and advanced processing techniques.

When designing new systems, it is important that Design Engineers consult the lamp manufacturer at an early stage to ensure that the lamp is optimised for the system and the application.

Cathode erosion in DC arc lamps normally occurs at a very low rate over many hundreds of hours. To guarantee this, thermal cycling of the cathode tip should be kept to an absolute minimum, current ripple should not exceed 1-2% and the lamp should be re-ignited as seldom as possible.

If the application demands that the current be modulated or frequently switched to a stand-by mode, this should be discussed with the Lamp Design Engineers. Heraeus Noblelight has developed cathodes especially suited to this mode of operation.

Gas fill contamination

Contamination of the fill gas in flash lamps is usually attributed to Oxygen released from the quartz (SiO_2) envelope. The process occurs when excessively high peak currents discharged through the lamp give rise to high instantaneous temperatures at the inner surface wall of the envelope. This leads to a reduction of the SiO_2 into Silicon and Oxygen. The electronegative nature of the Oxygen inhibits the electron flow and effectively raises the breakdown voltage of the lamp. This can have an effect on the ignition, triggering reliability and the simmering characteristic of the lamp.

Devitrification and an exceeding of the recommended average power ratings of lamps will also lead to Oxygen generation from the quartz envelope, as will any process which results in thermal overload of the quartz glass. Manufacturers' recommended lamp ratings should be adhered to at all times to ensure reliable operation.

Glass to metal seal failure

Failure of the seal is generally a very rare occurrence. It is usually caused either by a manufacturing fault or by a poorly designed mounting arrangement.

Lamp mounting must incorporate a degree of flexibility to enable the lamp to expand or contract due to thermal movement and also to absorb vibration. Large acoustic shock waves are generated in flash lamps during the current discharge. As the rapidly expanding plasma channel forces gas out of the arc region into the dead volume seal area, the lamp seal could crack if the lamp is mounted too rigidly.

The temperature of the seal should also not exceed 200°C for extended periods, otherwise the Tungsten lead through wire

Lamp seals	6
Electrodes	7
Gas fill and pressure	10
Envelope materials	13
Lamp triggering	16
Continuous lamp operation	18
Pulsed lamp operation	21
Lamp cooling	28
Lamp finishing/terminations	30
Lamp lifetime	31
Glossary	34
Lamp coding	35
Lamp assembly	35
Lamp formulae	36
Conversion factors	37
Technical data sheet	39

will oxidise and eventually cause the seal to fail. The glass to metal seal will withstand temperatures up to 600°C but only for limited periods of time.

To assist with this process Heraeus Noblelight considers it of prime importance to obtain as much information as possible from customers about the lamp's intended operation.

Envelope ageing

Deterioration of the quartz envelope is a complex issue and, as previously mentioned, can be influenced by sputtered electrode deposits and their interaction with the hot plasma.

There are however, thermal and pressure related mechanisms, independent of electrode deposits, which have an ageing effect on the envelope. In flash lamps stresses build up in the envelope wall following each discharge. These high instantaneous temperatures give rise to progressive vaporisation, devitrification and thermal cycling which will ultimately lead to fracture of the envelope. At very high pulse energies, the internal pressure wave can be forceful enough to overcome the mechanical strength of the envelope. Flash lamp explosion would then occur.

Lifetime calculations

For lamps operated with a pulse power supply, the preferred method for determining the life time of a flash lamp is to show the pulse energy (E_0) in terms of the corresponding explosion energy (E_x) at a specific pulse duration. Note that the explosion energy is the energy required to fracture the envelope in a single shot. This figure can be calculated from the following formula:

$$E_x = K_{ex} t^{\frac{1}{2}}$$

K_{ex} is the explosion energy constant (Ws) and can be found in all Heraeus Noblelight data sheets and lamp reference tables.

In the case of a pulse forming network t is the time constant of the circuit in seconds:

$$t = (LC)^{\frac{1}{2}}$$

C is the capacitance in Farads and L is the inductance in Henries.

Once E_0 is known and E_x has been calculated for a specific pulse duration, lamp life can be predicted with reasonable accuracy by using the following formula:

$$\text{Lifetime} = \left(\frac{E_0}{E_x} \right)^{-8.5}$$

Due to trapped radiation, derating may be necessary when lamps are used in conditions of tight optical coupling e.g. laser cavities. Typically 10 - 30% reductions are required. In correctly designed systems, lifetimes greater than 10^8 pulses are attainable under low loading conditions. When the bore current exceeds about 7500 Acm^{-2} , erosion of the wall becomes important. The exact calculation of this effect is not possible as it is often influenced by the details of a trigger system.

Being aware of these potential life limiting factors emphasises the economical and technical advantages of obtaining lamps from a widely experienced producer such as Heraeus Noblelight. Our objective is to optimise the performance of lamps, and to avoid or reduce these life determining effects in relation to the various constituent parts of the lamp and to the application.



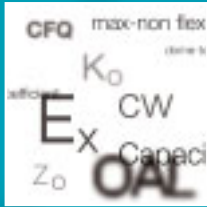

Glossary

Arc length (L_A) Arc length measured between electrode faces (mm)

Bead centres (L_B) The distance between the centres of the lamp seals (mm)

Bore (d) Internal diameter of the lamp (mm)

C Capacitance (F)

CFQ Clear Fused Quartz

CDQ Cerium Doped Quartz

CW Continuous Wave - a term used to describe continuous lamps

Damping coefficient (α) A damping factor for the resonance of the PFN circuit including the lamp - should be between 0.6 and 1.0 - ideally 0.8

Dome-to-dome An alternative term to describe Bead Centres. (mm)

D_c Connector diameter (mm)

D_p PEI sleeve diameter (mm)

E_0 Pulse energy (J)

E_x Energy required at a specific pulse duration for lamp life to equal one firing (J)

Fill pressure The cold fill pressure of gas which is pumped into the lamp during manufacture (Torr)

IGBT Insulated Gate Bi-polar Transistor

K_{ex} Lamp explosion energy constant. K_{ex} can be used to calculate E_x for any pulse duration

K_0 Lamp impedance constant ($\Omega A^{\frac{1}{2}}$)

L Inductance

L_c Connector length (mm)

L_L Lead length (mm)

L_s Stripped length (mm)

L_p PEI sleeve length (mm)

Max-non flex For lamps with flexible leads, this is the distance between the outer edges of the leads once they have been bent at right angles (mm)

Maximum average power Maximum level of Average input power to the lamp (W). This figure is based on the maximum continuous wall dissipation of the quartz

O Offset (mm)

O-ring centres (L_R) The distance between the centres of the anode and cathode o-rings (mm)

Overall length (OAL, L_0) The length of the lamp from the end of one connector to the end of the other (mm)

P Pressure (Torr)

PFN Pulse Forming Network

SCR Silicon Controlled Rectifier

SFQ Synthetic Fused Quartz

T Full Pulse width measured at 1/3 pulse height (seconds)

t Time constant of the circuit (seconds)

TDQ Titanium Doped Quartz

Z_0 Electrical impedance of the circuit (Ω)

Z_L Electrical impedance of the lamp (Ω).

Lamp seals	6
Electrodes	7
Gas fill and pressure	10
Envelope materials	13
Lamp triggering	16
Continuous lamp operation	18
Pulsed lamp operation	21
Lamp cooling	28
Lamp finishing/terminations	30
Lamp lifetime	31
Glossary	34
Lamp coding	35
Lamp assembly	35
Lamp formulae	36
Conversion factors	37
Technical data sheet	39

Lamp coding

Heraeus Noblelight uses a standardised system for lamp coding which consists of the lamp dimensions followed by a three digit lamp code.

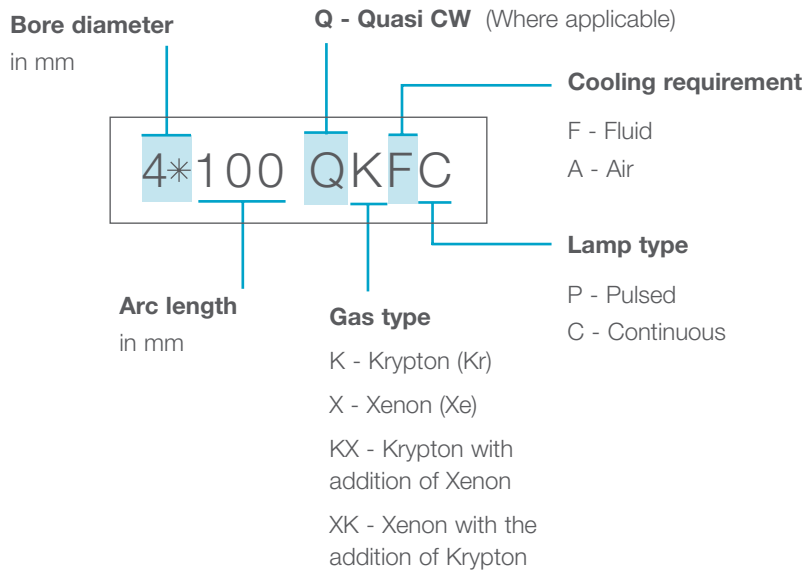
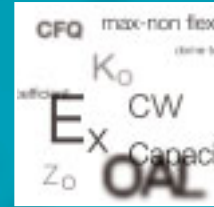

Lamp assembly

Finished lamp assembly



Quartz envelope



Electrical connection

Anode assembly



Beaded wire

Anode



Cathode assembly

Electrical connection



Cathode mount

Porous tungsten tip

Beaded wire



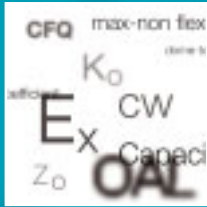

Lamp formulae

General

$$\text{Impedance constant } (K_0) = 1.28 \frac{\text{Arc length}}{\text{Bore}} \left(\frac{\text{Fill pressure in Torr}}{\text{Constant}} \right)^{0.2}$$

Constant = 450 for Xenon and 805 for Krypton

Adjustments

Nominal pulsed lamp calculations are based on 1mm wall Clear Fused Quartz.

For other materials and thicknesses, refer to figure 17 on page 15.

Square Wave power supply

$$\text{Pulse voltage } (V) = K_0 I^{1/2}$$

$$\text{Pulse energy } (E_0) = \frac{V^3 T}{K_0^2}$$

$$\text{Pulse power } (W) = K_0 I^{3/2}$$

$$\text{Current } (I) = \left(\frac{E}{K_0 T} \right)^{2/3}$$

PFN

$$\text{Time constant of circuit } (t) = (L C)^{1/2}$$

$$\text{Explosion energy } (E_x) = K_{EX} t^{1/2}$$

$$\text{Capacitance } (C) = \left(\frac{2 E_0 \alpha^4 t^2}{K_0^4} \right)^{1/3}$$

$$\text{Voltage } (V) = \left(\frac{2 E_0}{C} \right)^{1/2}$$

$$\text{Damping factor } (\alpha) = K_0 \left(\frac{C}{V t} \right)^{1/2}$$

$$\text{Life as a function of explosion energy} = \left(\frac{E_x}{E_0} \right)^{8.5}$$

$$\text{Average power} = E_0 f$$

$$\text{Full pulse width at 1/3 height } (T) = 3 t$$

$$\text{Impedance } (Z_0) = \left(\frac{L}{C} \right)^{1/2}$$

$$\text{Peak current } (I_{MAX}) \text{ approximation} = \left(\frac{V_0}{2 Z_0} \right)$$

$$\text{For changes in fill pressure, new } K_0 = \text{old } K_0 \left(\frac{\text{new pressure}}{\text{old pressure}} \right)^{1/5}$$

$$\text{For changes in } K_0, \text{ new pressure} = \text{old pressure} \left(\frac{\text{new } K_0}{\text{old } K_0} \right)^5$$

Lamp seals	6
Electrodes	7
Gas fill and pressure	10
Envelope materials	13
Lamp triggering	16
Continuous lamp operation	18
Pulsed lamp operation	21
Lamp cooling	28
Lamp finishing/terminations	30
Lamp lifetime	31
Glossary	34
Lamp coding	35
Lamp assembly	35
Lamp formulae	36
Conversion factors	37
Technical data sheet	39

Conversion factors

Length

mm → inches	x by 0.039
inches → mm	x by 25.4

Temperature

°C → °F	x by 1.8, then add 32
°F → °C	subtract 32, then x by 0.556

Volume

Litres → UK Gallons	x by 0.22
UK Gallons → Litres	x by 4.54
Litres → US Gallons	x by 0.26
US Gallons → Litres	x by 3.78

Pressure

Pascal → Torr	x by 0.0075
Torr → Pascal	x by 133
psi → Torr	x by 51.715
Torr → psi	x by 0.0193
millibar → Torr	x by 0.75
Torr → millibar	x by 1.33

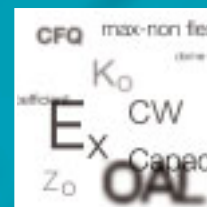

Data accuracy

Heraeus Noblelight Limited endeavours to ensure that the information in this technical reference book is correct and fairly stated, but does not accept liability for any error or omission.

Technical data

Customer name

Lamp ref/Drawing no.

Address

tel.

fax

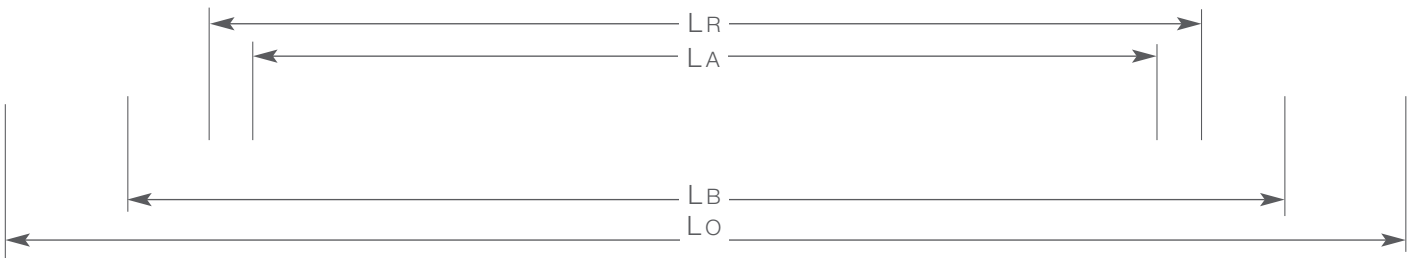

Arc length (LA) =	mm	O-Ring centres (LR) =	mm	Lamp OD =	mm
Body length (LB) =	mm	Lamp bore =	mm	Pass-through diameter =	mm
Overall length (LO) =	mm	Side-arm position			

- Envelope material**
- CFQ
 - CDQ
 - SFQ
 - TDQ

- Gas Fill**
- Krypton
 - Xenon
 - Mix: %Krypton, & %Xenon
- Pressure Torr

- Lamp type**
- Pulse** Cooling: Air Forced air Water
 - Operation: PFN Square wave

Capacitance	µF	Pulse current	A	Pulse length	µs/ms	Trigger voltage	kV
Inductance	µH	Pulse voltage	V	o/c simmer	V	Ko	ΩA ²
Voltage	V	Pulse energy	J	Simmer current	mA	Avg. power	W
				Simmer voltage	Vmax	Frequency	Hz

- Continuous** Operating current A Operating voltage V Voltage tolerance ± V

Connector type	Base	Offset base	Flying lead	Plain	PEI Sleeve
measurements in mm					
	L =	L =	L _L =	L =	L _P =
	D =	O =	L _S =	Finish: <input type="radio"/> plain	D _P =
	Material =	D =	Insulation material =	<input type="radio"/> nickel	L _C =
				<input type="radio"/> tinned	D _C =
			Max non-flex =		O =

Additional information/special requirements

(please continue on separate sheet if necessary)

Heraeus Noblelight Limited

Cambridge Science Park,
Milton Road, Cambridge
CB4 0GQ UK.

Telephone (+ 44) 1223 423324

Fax (+44) 1223 423999

Email hnl-laserlamps@heraeus.com

Heraeus Noblelight Limited

Cambridge Science Park
Milton Road, Cambridge, CB4 0GQ
United Kingdom
Telephone (+ 44) 1223 423324
Fax (+44) 1223 423999
Email hnl-laserlamps@heraeus.com
www.heraeus-noblelight.com