

Victaulic

# AWWA Grooved End Pipe Products Price List



**2012-AWWA**

EFFECTIVE JUNE 4, 2012



**Victaulic<sup>®</sup>**

# Table of Contents

Gasket Selection . . . . .	2	No. 60-C Cap . . . . .	17
Victaulic Lubricant . . . . .	2	No. 35-C Cross . . . . .	17
<b>AWWA COUPLINGS</b>			
Coupling Coating Options . . . . .	3	No. 25-C Reducing Tee . . . . .	18
Style 31 Standard Coupling . . . . .	3	No. 30-CR Reducing Lateral . . . . .	19
Style 307 Transition Coupling . . . . .	4	No. 100-CR 90° Long Radius Elbow . . . . .	19
Style 341 Vic-Flange® Adapter . . . . .	4	No. 30-CR Reducing Lateral . . . . .	20
<b>CUSTOMIZED PIPE JOINING AND REPAIR SOLUTIONS</b>			
Depend-O-Lok Coupling . . . . .	5	No. 100-CR 90° Long Radius Elbow . . . . .	20
FluidMaster/AirMaster . . . . .	5	No. 35-CR Reducing Cross . . . . .	21
Expansion Joint . . . . .	5	No. 50-C Concentric Reducer . . . . .	22
<b>VIC-RING® JOINT ASSEMBLY</b>			
Vic-Ring Shouldered Check Sheet . . . . .	6	No. 51-C Eccentric Reducer . . . . .	23
Style 41 Coupling . . . . .	7	No. 21-C Bullhead Tee . . . . .	24
Style 44 Coupling . . . . .	8	No. 33-C True Wye . . . . .	24
<b>AWWA VALVES</b>			
Plug Valve Disc Coating/Seal Options . . . . .	9	<b>Base Fittings</b>	
Series 365 with Operators . . . . .	9	No. 10-CB 90° Base Elbow . . . . .	24
List Adders for Plug Valves . . . . .	9	No. 20-CB Base Tee . . . . .	24
Plug Valve Actuator Information . . . . .	10	No. 100-CB 90° Base Long Radius Elbow . . . . .	25
Gear Operator Accessories for Series 365 Vic-Plug Valves . . . . .	10	No. 25-CB Reducing Base Tee . . . . .	26
Series 317 AWWA Check Valve . . . . .	11	No. 10-CF 90° Flare . . . . .	28
Series 317 Kits . . . . .	11	No. 100-CF 90° Long Radius Flare . . . . .	27
List Adders for Check Valves . . . . .	12	No. 10-CS 90° Side Outlet . . . . .	27
Series 318 Sump Ejector Kit . . . . .	12	No. 20-CS Tee Side Outlet . . . . .	27
<b>AWWA FITTINGS</b>			
Fitting Coating Options . . . . .	13	No. 43-CF Straight Flare . . . . .	28
Tapped Fittings . . . . .	14	<b>PIPE PREPARATION TOOLS</b>	
No. 10-C 90° Elbow . . . . .	14	Cut Grooving Tools	
No. 11-C 45° Elbow . . . . .	14	VG28GD . . . . .	30
No. 12-C 22½° Elbow . . . . .	15	VG824 . . . . .	31
No. 13-C 11¼° Elbow . . . . .	15	VG412 . . . . .	32
No. 100-C 90° Long Radius Elbow . . . . .	15	VG . . . . .	32
No. 10-CR Reducing Elbow . . . . .	16	PT-100-A Go/No-Go Pipe Tape . . . . .	33
No. 20-C Tee . . . . .	17	Terms and Conditions of Tool Rental . . . . .	34
No. 30-C 45° Lateral . . . . .	17	Terms and Conditions of Tool Sale, Tool Warranty . . . . .	35
		Terms and Conditions of Sale . . . . .	Inside Back Cover
		Warranty . . . . .	Inside Back Cover
		Victaulic US Sales and Service Centers . . . . .	Back Cover

# Gaskets

## Gasket Selection Guide

**IMPORTANT – Please read before ordering. Gasket selection must always be specified on order.**

### FlushSeal® Standard Gasket

STYLE 31

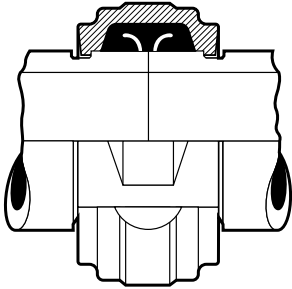

GRADE	TEMP. RANGE	COMPOUND	COLOR CODE	* GENERAL SERVICE RECOMMENDATIONS
<b>S</b> †	-20°F to +180°F	Nitrile	Orange Stripe	Specially compounded to conform to ductile pipe surfaces. Recommended for petroleum products, air with oil vapors, vegetable and mineral oils within the specified temperature range; except for hot dry air over +140°F and water over +150°F. <b>NOT RECOMMENDED FOR HOT WATER SERVICES.</b>
<b>M</b> †	-20°F to +200°F	Halogenated Butyl	Brown Stripe	Recommended for a variety of dilute acids, oil-free air and many chemical services. Readily conforms to ductile pipe surfaces. UL classified in accordance with ANSI/NSF 61 for cold +86°F/+30°C potable water service. <b>NOT RECOMMENDED FOR PETROLEUM SERVICES.</b>
<b>L</b>	-30°F to +350°F	Silicone	Red Gasket	Recommended for dry heat, air without hydrocarbons to +350°F and certain chemical services.

\* Refer to VICTAULIC GASKET SELECTION GUIDE (Request 05.01) for specific service recommendations.

Services listed are Gasket Service Recommendations only. It should be noted that there are services for which these gaskets are not recommended. Reference should always be made to the latest Victaulic Gasket Selection Guide for specific gasket service recommendations and for a listing of services which are not recommended.

† Provided as standard gasket for Styles 31 and 307 couplings plus Style 341 Vic-Flange Adapter. Specify choice on order.

### Victaulic Lubricant



LUBRICANT 4½ oz. Tube or 1 Quart Containers	Price Each
<b>PACK</b> With 12 Tubes – 4½ oz. Each	<b>\$296.50</b>
<b>CONTAINER</b> One Quart – Container	<b>129.00</b>

To ensure easy assembly and service of all your Victaulic installations, be sure to include plenty of Victaulic Lubricant with every order. The following chart provides a rough gauge of quantities recommended, based on the number of units sold.

**NOTE: Items listed in shaded areas are non-cancellable and non-returnable.**

LUBRICANT USAGE GUIDE								
Size of Gasket Inches	Number of Gaskets		Size of Gasket Inches	Number of Gaskets		Size of Gasket Inches	Number of Gaskets	
	Per Tube	Per Quart		Per Tube	Per Quart		Per Tube	Per Quart
<b>2</b>	55	400	<b>8</b>	13	100	<b>16</b>	6	45
<b>3</b>	36	270	<b>10</b>	11	80	<b>18</b>	5	35
<b>4</b>	26	200	<b>12</b>	8	60	<b>20</b>	4	30
<b>6</b>	17	125	<b>14</b>	7	50	<b>24</b>	3	20

# Products for AWWA Grooved End Pipe

## Standard AWWA Couplings

### Coating Options

Victaulic couplings and flange adapters are available in a variety of coatings. This is a list of the most common coatings. **Victaulic couplings are supplied with a Tnemec Series 37-77 unless specified otherwise.** For more information regarding available coatings, contact Victaulic.

Coating	% Increase
Asphalt	0
Tnemec Series 37-77	0
Tnemec Series 20	#
Tnemec Series 66	8
Tnemec Series 69	8
Tnemec Series 90 - 97	12
Tnemec Series 104	8

Coating	% Increase
Tnemec Series 135	8
Tnemec Series 140	8
Tnemec Series 160	#
Tnemec Series 161	#
Coal Tar Epoxy (T46H413)	17
Tnemec Series 1	5
Wasser MC-FerroClad	5

# Contact Victaulic for product details.

## Standard Coupling

### STYLE 31

With FlushSeal Gasket  
Request publication 23.02.



### STYLE 31 – GRADE “S” OR “M” FLUSHSEAL GASKET

PIPE Inches		Coupling Complete w/Grade “S” or “M” FlushSeal Gasket †	Spare Parts							
Nom. Size	Outside Dia.		Wgt. Each Lbs	Price Each		Grade “S” or “M” FlushSeal Gasket Only Price Ea.	Grade “L” Silicone FlushSeal Gasket Only Price Ea.	Plated Bolt & Nut		
				Painted	Galv.			No. * Bolts	Size Inches	Price Each
3	3.96	4.3	<b>\$137.00</b>	\$173.00	<b>\$40.50</b>	\$162.00	2	½ x 2¾	<b>\$15.00</b>	
4	4.80	6.4	<b>152.00</b>	202.50	<b>44.00</b>	175.00	2	¾ x 3¼	<b>18.00</b>	
6	6.90	8.5	<b>226.00</b>	294.00	<b>88.50</b>	205.50	2	¾ x 3¼	<b>18.00</b>	
8	9.05	15.4	<b>331.50</b>	450.50	<b>117.50</b>	253.50	2	¾ x 5	<b>28.00</b>	
10	11.10	22.5	<b>438.50</b>	609.50	<b>131.50</b>	293.00	2	¾ x 5	<b>28.00</b>	
12	13.20	30.0	<b>644.00</b>	876.50	<b>155.00</b>	306.50	2	7⁄8 x 5	<b>37.00</b>	
14	15.30	40.8	<b>842.00</b>	1157.00	<b>171.00</b>	333.50	4	1 x 3½	<b>40.50</b>	
16	17.40	61.3	<b>1063.00</b>	1672.50	<b>222.50</b>	402.00	4	1 x 3½	<b>40.50</b>	
18	19.50	80.0	<b>1325.50</b>	1924.50	<b>277.50</b>	574.50	4	1 x 3½	<b>40.50</b>	
20	21.60	76.0	<b>1549.50</b>	2133.00	<b>370.50</b>	674.50	4	1½ x 4	<b>63.50</b>	
24	25.80	104.0	<b>1982.00</b>	2771.50	<b>504.50</b>	742.00	6	1½ x 4	<b>63.50</b>	
30	32.00	162.0	<b>3903.00</b>	5182.50	<b>1313.50</b>	+	6	1½ x 4	<b>63.50</b>	
36	38.30	200.0	<b>4436.50</b>	5994.00	<b>1488.00</b>	+	6	1½ x 4	<b>63.50</b>	

† Surcharge for couplings supplied without gasket. Contact Victaulic for pricing.

**NOTE: Items listed in shaded areas are non-cancellable and non-returnable.**

\* Number of bolts equals number of segments supplied.

+ Quoted on application. Contact Victaulic for pricing and availability.

Sizes 4” – 16” are UL Listed/FM Approved for underground fire protection water supply systems.



# Products for AWWA Grooved End Pipe

## Transition Coupling

### STYLE 307

(For connecting AWWA to IPS pipes, valves, and fittings)  
Request publication 23.03.



### STYLE 307 – GRADE “S” OR “M” FLUSHSEAL GASKET

Nom. Size	PIPE Inches		Aprx. Wgt. Ea.	COUPLING COMPLETE † With Grade “M” or “S” FlushSeal Gasket		Grade “M” or “S” FlushSeal Gasket Only Price Ea.	SPARE PARTS		
	Mating Pipe O.D.			Price Each			Bolt & Nut		
	IPS Steel	AWWA Ductile		Painted	Galv.		No. *	Size Inches	Price Each Plated
3	3.500	3.960	6.0	\$214.50	\$287.50	\$91.00	2	½ x 2¾	\$15.00
4	4.500	4.800	8.0	245.50	337.50	94.50	2	½ x 3¼	15.00
6	6.625	6.900	9.0	299.00	406.50	102.00	2	5⁄8 x 3¼	18.00
8	8.625	9.050	18.0	372.00	553.00	113.00	2	¾ x 5	28.00
10	10.750	11.100	22.0	477.50	703.00	198.00	2	7⁄8 x 6½	46.50
12	12.750	13.200	31.1	634.50	946.50	205.00	2	7⁄8 x 6½	46.50

† Surcharge for couplings supplied without gasket. Contact Victaulic for pricing.

**NOTE: Items listed in shaded areas are non-cancellable and non-returnable.**

\* Number of bolts equals number of segments supplied.

## Vic-Flange® Adapter

### STYLE 341

Request publication 23.04.



### STYLE 341 – GRADE “S” OR “M” GASKET

PIPE Inches		Weight Each Lbs	Vic-Flange Adapter Complete with Grade “S” or “M” Gasket †		SPARE PARTS		
Nominal Size	Outside Diameter		Price Each		Flange Washers	S or “M” Gasket Only Price Each	Silicone “L” Gasket Only Price Each
			Painted	Galv.			
STYLE 341 - Hinged							
3	3.96	5.4	\$239.50	\$300.50	\$102.50	\$57.00	+
4	4.80	8.2	266.00	348.50	118.50	57.00	+
6	6.90	12.0	349.50	465.50	164.50	63.50	+
8	9.05	17.4	442.00	600.00	208.00	72.50	+
10	11.10	24.6	647.00	874.50	288.00	83.00	+
12	13.20	34.4	841.50	1152.50	421.00	98.50	+
STYLE 341 - Four Piece							
14	15.30	61.0	\$1812.50	\$2398.50	\$459.00	\$117.50	+
16	17.40	80.0	2096.50	2833.50	815.50	127.00	+
18	19.50	98.8	2573.00	3480.50	869.00	179.50	+
20	21.60	113.9	3095.00	4157.50	+	194.00	+
24	25.80	134.9	3961.50	5253.50	+	214.50	+

† Surcharge for couplings supplied without gasket. Contact Victaulic for pricing.

**NOTE: Items listed in shaded areas are non-cancellable and non-returnable.**

Vic-Flange adapters sizes 4 – 12” are UL Listed/FM Approved for underground fire protection water supply systems.

+ Quoted on application. Contact Victaulic for pricing and availability.

# Products for AWWA Grooved End Pipe

---

## Depend-O-Lok Couplings



- Provides a reliable, economical alternative to traditional bolted sleeve-type couplings.
- Available in a variety of styles to meet specific application requirements, including:
  - **Bolted Split-Sleeve Flexible Coupling**  
Unrestrained, flexible bottle-tight joints (E x E)
  - **Bolted Split-Sleeve Restrained Flexible Coupling**  
Fully restrained pipe joints without external harnessing (F x F)
  - **Bolted Split-Sleeve Expansion Couplings**  
Pipe joints that provide for thermal expansion and contraction (F x E)
- D-O-L couplings meet or exceed the design, material and performance standards set forth in AWWA C-219.

## Master Series Fluid/AirMaster

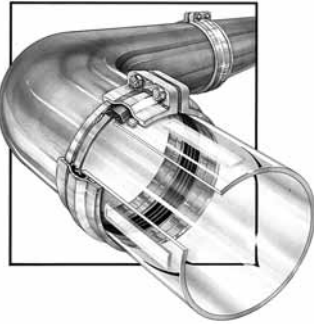

- Designed to provide fully restrained joints for air and fluid-conveying pipelines.
- Shouldered couplings that are designed to operate at design pressures of the system.
- Meet or exceed the performance standards set forth in AWWA C-606.

## Expansion Joint

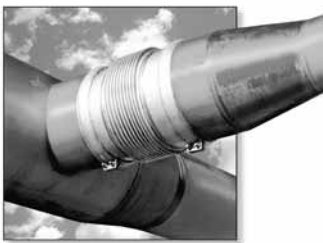

- Complete line of expansion joints.
- Offers solutions for accommodating thermal expansion and contraction of pipelines.
- Products include:
  - **OmniFlex**  
Stainless Steel Bellows-Type Expansion Joints  
(can also accommodate lateral movement)
  - **D-O-L Bolted Split-Sleeve Expansion Couplings**  
(accommodates expansion/contraction up to 6½")
  - **Paragon Expansion Joints**  
Fabricated Mechanical Expansion Joints

For more information on the above products, contact the Victaulic Customer Care Center:

**Phone: 1-800-841-6624**

# Products for AWWA Grooved End Pipe

## Vic-Ring Shouldered Joint Check Sheet



Send US inquiries to: engrprodchecksheets@victaulic.com or fax to: 610-923-3010  
 To speak with a Customer Service representative in the US, please call 1-800-PICK-VIC

The joining of pipe with a suitable Victaulic Vic-Ring coupling presents individual considerations that require review by a Victaulic Piping System expert who is experienced in special pipe joining applications. For more information please contact Victaulic, or refer to Victaulic Company's Vic Ring submittals 16.01 and 16.02 available at www.victaulic.com.

**TO OBTAIN A QUOTE, PLEASE PROVIDE THE INFORMATION REQUESTED BELOW.**

### CUSTOMER INFORMATION:

PROJECT NAME:	PROJECT LOCATION:
VICTAULIC SALES:	BID DATE:
CONTRACTOR:	CONTRACTOR NAME:
PHONE/FAX:	EMAIL:
DISTRIBUTOR/FABRICATOR:	CONTACT NAME:
PHONE/FAX:	EMAIL:

### APPLICATION DATA:

JOINT TYPE: <input type="checkbox"/> Pipe to Pipe (two Rings required) <input type="checkbox"/> Pipe to Shoulder (one Ring req.) <input type="checkbox"/> Pipe to Shoulder Valve (one Ring req.)			
NOMINAL PIPE SIZE:	ACTUAL PIPE OD:	SCHEDULE:	WALL THICKNESS:
PIPE MATERIAL: <input type="checkbox"/> Carbon Steel <input type="checkbox"/> Ductile Iron - Requires special pipe preparation as well as welding processes. <input type="checkbox"/> Stainless Steel - Type: _____			
COUPLING BOLTS / NUTS MATERIAL: <input type="checkbox"/> Zinc Plated Carbon Steel (Std.) <input type="checkbox"/> 316 Stainless Steel <input type="checkbox"/> Galvanized Carbon Steel		COUPLING PROTECTIVE COATING: <input type="checkbox"/> Other (please describe) <input type="checkbox"/> T37H-77 (Standard) <input type="checkbox"/> Liquid Epoxy (T140) _____	
MEDIA FLUID:		WORKING PRESSURE:	TEST PRESSURE:
GASKET GRADE:	TYPE: <input type="checkbox"/> Standard <input type="checkbox"/> FlushSeal®	TEMPERATURE RANGE:     MIN: _____     MAX: _____	

### CONFIGURATION INFORMATION:

COUPLING:     STYLE: _____     SIZE: _____     QTY: _____     (# of Joints)			
RINGS:     STYLE: _____     SIZE: _____     QTY: _____     (per Joint)			
RING TYPE: <input type="checkbox"/> TYPE D <input type="checkbox"/> TYPE E <input type="checkbox"/> TYPE B <input type="checkbox"/> TYPE C		WELD DETAIL: <input type="checkbox"/> ABRASIVE SERVICE <input type="checkbox"/> NON ABRASIVE SERVICE	
PIPE LINING: (if applicable): Lining Material: _____     Thickness: _____ <input type="checkbox"/> Corrosion and Abrasion <input type="checkbox"/> Abrasion Only			

# Products for AWWA Grooved End Pipe

## Vic-Ring® Couplings

Style 41 and 44 couplings are used in conjunction with Vic-Ring adapters when it is not possible to direct groove pipe. Pipe to pipe connections require two Vic-Ring adapters per joint. Contact Victaulic for pricing on Vic-Ring adapters. For further information on the Vic-Ring system request publication 16.01.

### Style 41 Couplings

Request publication 16.04.



#### STYLE 41 COUPLINGS

PIPE Inches	Max. Work. Pressure per Joint	Coupling	Spare Parts				
			Nominal Size	No. of Bolts	Bolt Dim. Size Inches	Bolt/Nut Price Ea.	Grade "E" Gasket Price Ea.
30	90	\$3384.00		6	1½ x 5½	\$63.50	\$830.00
36	90	3629.00		6	1½ x 5½	63.50	1011.00
38	90	3807.00		6	1¼ x 5½	185.00	1066.00
42	90	5170.50		8	1¾ x 5¾	216.00	1108.00
46	90	5422.50		8	1½ x 5¾	231.00	1108.00
48	90	6042.00		8	1¾ x 6	404.50	1261.00
54	90	7010.50		8	1¾ x 6	404.50	1386.00
60	90	+		10	1¾ x 6	535.50	1611.00
66	90	+		24	1½ x 5¾	231.00	+

**NOTE: Items listed in shaded areas are non-cancellable and non-returnable.**

+ Quoted on application. Contact Victaulic for pricing and availability.



# Products for AWWA Grooved End Pipe

## Style 44 Couplings

Request publication 16.05.



### STYLE 44 COUPLINGS

PIPE Inches	Max. Work. Pressure per Joint	Coupling	Spare Parts			
			Price Each Painted	No. of Bolts	Bolt Dim. Size Inches	Bolt/Nut Price Ea.
Nominal Size	psi					
4	175	\$356.50	2	5/8 x 4	\$24.00	\$81.00
6	175	380.50	2	5/8 x 4	24.00	144.50
8	175	427.50	2	3/4 x 5	28.00	148.50
10	175	457.50	2	3/4 x 5	28.00	153.50
12	175	499.50	2	7/8 x 5 1/2	43.00	201.00
14	175	626.50	4	1 x 3 1/2	40.50	229.50
16	175	973.50	4	1 x 3 1/2	40.50	264.50
18	175	1070.50	4	1 x 3 1/2	40.50	327.50
20	175	2122.00	4	1 1/4 x 5 1/2	185.00	439.50
24	175	2351.00	6	1 1/4 x 3 1/2	63.50	609.50
30	175	3842.00	6	1 1/2 x 5 3/4	231.00	830.00
36	175	4580.00	6	1 1/2 x 5 3/4	231.00	1011.00
42	175	5975.00	8	1 3/4 x 6	404.50	1108.00
48	175	6952.50	16	1 3/8 x 5 3/4	216.00	1261.00
54	175	8022.50	16	1 1/2 x 5 3/4	231.00	1386.00
60	175	12282.00	20	1 1/2 x 5 3/4	231.00	1611.00

**NOTE: Items listed in shaded areas are non-cancellable and non-returnable.**

# Products for AWWA Grooved End Pipe

## Series 365 Vic-Plug Valves

### Plug Valve Disc Coating/Seal Options

#### SERIES 365

Request publication 23.06.



Optional plug seal coatings are available – pricing and availability on application. Valve supplied standard with Nitrile (Grade “T”) coated plug. Contact Victaulic for details.

- Grade “E” EPDM – (P- \_ \_ \_ 7121-00)
- Grade “O” Fluoroelastomer – (P- \_ \_ \_ 7131-00)

**P - 080 - 7 1 1 1 - 80**

Type	Nom. In./mm	Size Code	Pressure Rating	Body Material	Plug Coating	Seat	Operator
P	3"/80	030	7 - 175 psi full bi-directional (1)	1 - Iron	1 - Nitrile - "T"	1 - Nickel	00 - Bare
	4"/100	040		3 - Coated iron (2)	2 - EPDM - "E"	7 - Glass Lined/ Nickel Seat	01 - 2" Square Nut Only
	6"/150	060		7 - Glass lined	3 - Fluoroelastomer - "O"		10 - Std. Handle (2)
	8"/200	080					11 - Std. Handle with memory stop (2)
	10"/250	100					80 - Gear Op w/Handwheel
	12"/300	120					81 - Gear Op w/2" Nut 82 - Gear Op w/Chainwheel 99 - Special (1)

(1) Details must be supplied with order.

(2) 3, 4 and 6"/80, 100 and 150 mm only.

### Series 365 Vic-Plug Valves with Operators

Request publication 23.06.

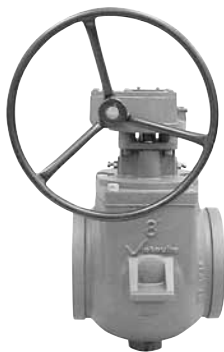

#### SERIES 365 WITH OPERATORS

Nom. Size Inches	Bare	With Lever	Gear Op. w/ Handwheel or 2" nut	Gear Op. w/ Chainwheel
3	\$1155.50	\$1285.00	\$2017.00	\$2556.00
4	1222.00	1382.00	2232.50	2830.00
6	1740.50	1848.00	2501.00	3019.00
8	2708.00	-	3989.50	5294.50
10	4090.50	-	6406.00	8034.00
12	5298.50	-	8104.50	+

**NOTE: Items listed in shaded areas are non-cancellable and non-returnable.**

### List Adders for Vic-Plug Valves

#### SERIES 365 LIST ADDERS

Nom. Size Inches	Glass Lining	Epoxy Lining Interior	Epoxy Coating Exterior
3	\$562.50	\$201.00	\$151.50
4	613.50	201.00	177.00
6	695.00	241.50	196.50
8	884.50	329.50	247.00
10	1004.50	389.00	290.50
12	1172.00	548.50	326.50

**NOTE: Items listed in shaded areas are non-cancellable and non-returnable.**

Epoxy paints included in above are Tnemec Series 20, 66, 69, 104, 135, 140, 160, 161.

# Products for AWWA Grooved End Pipe

## Plug Valve Actuator Information

(Victaulic offers a variety of extensions/ manual operators and accessories. Contact Victaulic for pricing.)

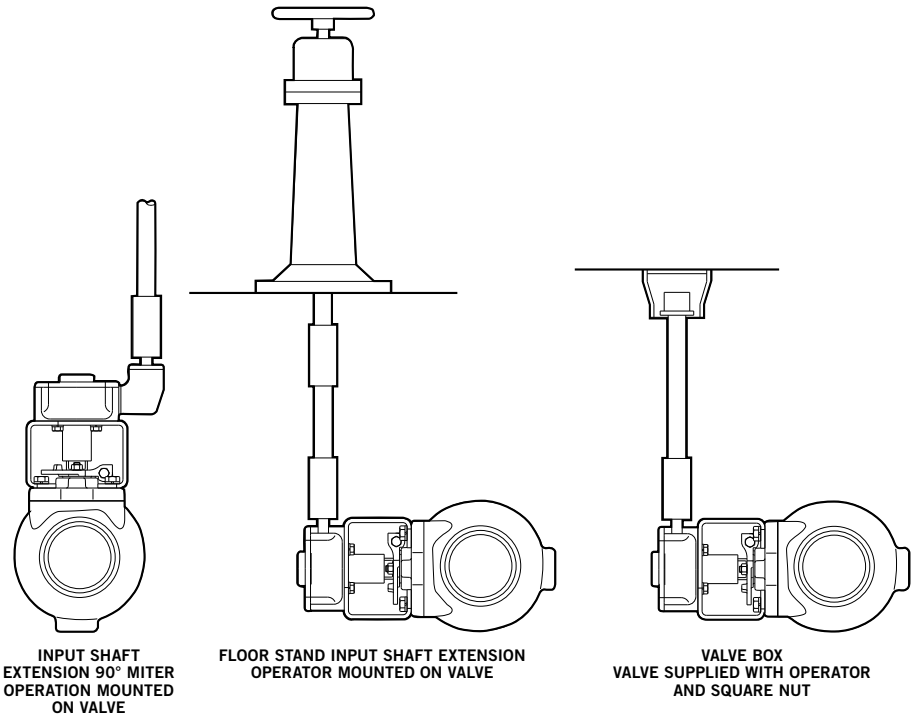

## Gear Operator Accessories for Series 365 Vic-Plug Valves

### GEAR OPERATOR ACCESSORIES

Size Inches	Handwheel Only	2" Nut	Chain Wheel Kit	Gear Operator Only	Chain Per Foot
3	\$170.00	\$170.00	\$493.50	\$1199.50	\$11.00
4	170.00	170.00	493.50	1199.50	11.00
6	170.00	170.00	700.00	1199.50	11.00
8	291.50	291.50	907.50	1199.50	11.00
10	291.50	291.50	907.50	2112.00	11.00
12	291.50	291.50	907.50	3457.00	11.00

**NOTE: Items listed in shaded areas are non-cancellable and non-returnable.**

### SERIES 365 VALVE EXTENSION STEMS – CARBON STEEL STEM WITH 2" SQUARE NUT ON TOP

Valve Size Inches	Stem Diameter Inches	1st 5 ft. with pin top & bottom	Each additional foot
3 – 10	1	+	+
12	1¼	+	+

**NOTE: Items listed in shaded areas are non-cancellable and non-returnable.**

+ Quoted on application. Contact Victaulic for pricing and availability.

Stainless steel extension stems available priced on application. Contact Victaulic for pricing and availability.

NOTE: For automatic actuation, contact your local valve automation center for pricing and availability.

# Products for AWWA Grooved End Pipe

## Series 317 AWWA Check Valves

Request publication 23.09.



BARE



ARM AND WEIGHT



ARM AND SPRING



ARM AND AIR CUSHION

### SERIES 317 AWWA CHECK VALVES

Nom. Size	Bare Bronze Seat or "T" Nitrile Seat		Arm and Weight Bronze Seat or "T" Nitrile Seat		Arm and Spring Bronze Seat or "T" Nitrile Seat		Arm and Air Cushion Bronze Seat or "T" Nitrile Seat	
	Aprx. Wgt. Each Lbs	Price Each	Aprx. Wgt. Each Lbs	Price Each	Aprx. Wgt. Each Lbs	Price Each	Aprx. Wgt. Each Lbs	Price Each
3	50.0	\$1450.00	57.0	\$2610.50	54.0	\$2610.50	65.0	\$2983.00
4	70.0	1933.00	77.0	3092.00	74.0	3092.00	85.0	3466.00
6	120.0	2577.00	127.0	3736.00	124.0	3736.00	135.0	4463.00
8	225.0	4174.00	242.0	5186.00	233.0	5186.00	259.0	6182.50
10	350.0	6640.50	367.0	7438.00	358.0	7438.00	384.0	9497.50
12	460.0	8690.00	477.0	9851.50	468.0	9851.50	494.0	13328.00

**NOTE: Taps available as special order. Contact Victaulic for details.**

NOTE: Specify choice on order.

## Series 317 Kits

### SERIES 317 KITS

Nominal Size	Kits - Price Each		
	Arm and Weight	Arm and Spring	Arm and Air Cushion
3	\$1093.50	\$1093.50	\$2043.50
4	1093.50	1093.50	2043.50
6	1093.50	1093.50	2297.00
8	1093.50	1093.50	2810.00
10	1093.50	1093.50	4193.50
12	1093.50	1093.50	6044.50

**NOTE: Items listed in shaded areas are non-cancellable and non-returnable.**

Note: Kits include all hardware and instructions necessary to field-convert valve to desired option.

# Products for AWWA Grooved End Pipe

## List Adders for Check Valves

### SERIES 317 LIST ADDERS

Nom. Size Inches	Epoxy Lining Interior	Epoxy Coating Exterior
3	\$197.00	\$151.50
4	197.00	176.50
6	241.50	196.50
8	329.50	247.00
10	388.50	290.50
12	548.50	326.00

**NOTE: Items listed in shaded areas are non-cancellable and non-returnable.**

Epoxy paints included in above are Tnemec Series 20, 66, 69, 104, 135, 140, 160, 161.

**C - 040 - 1 1 1 1 - 10**

Type	Act. In./mm	Size Code	Pressure Rating	Body Material	Closure Coupling Gasket Grade	Seat	Accessories*
C	3/80 4/100 6/150 8/200 10/250 12/300	030 040 060 080 100 120	1 - 175 psi 9 - Special*	1 - Iron 3 - Coated Iron** 7 - Glass lined 9 - Special*	1 - (S) Nitrile 2 - (M) Hologenated Butyl 3 - (V) Neoprene 4 - (O) Fluoroelastomer 9 - Special*	1 - Bronze 2 - (T) Nitrile 3 - (E) EPDM 4 - (V) Neoprene 5 - (O) Fluoroelastomer 9 - Special*	10 - Bare shaft on right side of valve 11 - Lever with Adjustable Spring mounted on right side of valve 12 - Lever with Weight mounted on right side of valve 13 - Air Cushion with Adjustable Spring mounted on right side of valve 20 - Bare shaft on left side of valve 21 - Lever with Adjustable Spring mounted on left side of valve 22 - Lever with Weight mounted on left side of valve 23 - Air Cushion with Adjustable Spring mounted on left side of valve 9 - Special*

\*Details must be supplied with order.

\*\*Details of coating must be supplied with order.

## Series 318 Sump Ejector Kit \*

Request publication 23.12.

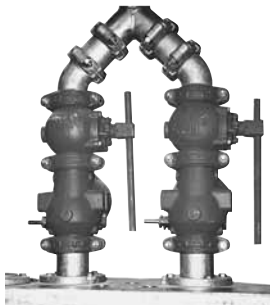

### SERIES 318 SUMP EJECTOR KIT

Size Inches	Wgt. Assembled	Price Each
3	91.4	\$3243.00
4	128.8	3695.00
6	221.4	5185.50

SERIES 318 – SUMP EJECTOR KIT CONSISTS OF THE FOLLOWING COMPONENTS:

Quantity	Component
1	Series 365 Vic-Plug Valve
1	Series 317 AWWA Check Valve †
2	Style 307 Transition Coupling
1	Style 31 AWWA Coupling

\* Kits are supplied unassembled.

† Arm and Spring Kit standard.



# Products for AWWA Grooved End Pipe

## AWWA Fittings

Request publication 23.05.



- Conform to AWWA C-606 rigid groove specifications and ANSI A-21.10/AWWA C-110 end to end dimensions.
- Fittings supplied with an alkyd phenolic primer. Optional coatings/linings include coal tar epoxy, organic zinc-rich primer, cement and others. Cast surfaces equivalent to SSPC-SP6 prior to coating unless otherwise specified. Contact Victaulic with details when ordering special coatings/linings.
- Flanged by grooved fittings available upon request. Contact Victaulic for details.

## Coating Options

Victaulic fittings are available in a variety of coatings. This is a list of the most common coatings.

**Victaulic fittings are supplied with a Tnemec Series 37-77 unless specified otherwise.**

Coating	% Increase
Asphalt	0
Tnemec Series 37-77	0
Tnemec Series 20	#
Tnemec Series 66	8
Tnemec Series 69	8
Tnemec Series 90 - 97	12
Tnemec Series 104	8

Coating	% Increase
Tnemec Series 135	8
Tnemec Series 140	8
Tnemec Series 160	#
Tnemec Series 161	#
Coal Tar Epoxy (T46H413)	17
Tnemec Series 1	5
Wasser MC-FerroClad	5

# Contact Victaulic for product details.

# Products for AWWA Grooved End Pipe

## Tapping Locations

Request publication 23.05.

### Tapped Fittings

- Victaulic can supply tapped fittings on order to ANSI B16.1 dimension locations.
- Specify fitting size, tap location by letter (as shown below) and tap size – NPT dimensions on order.
- **Tap price must be added after calculating coating pricing.**
- **Cast iron fittings cannot be tapped per table below. Contact Victaulic for details.**

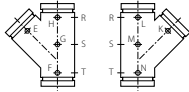

45° LATERAL STRAIGHT & REDUCING

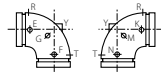

90° ELBOW STRAIGHT SIZE

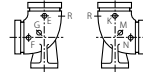

90° BASE ELBOW STRAIGHT & REDUCING

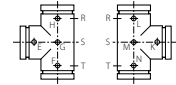

TEE STRAIGHT SIZE

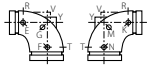

90° ELBOW REDUCING SIZE



90° ELBOW

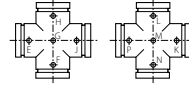

CROSS STRAIGHT SIZE

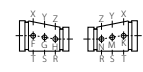

ECCENTRIC REDUCER

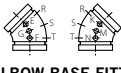

45° ELBOW BASE FITTINGS

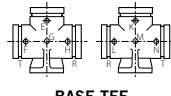

BASE TEE

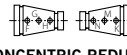

CONCENTRIC REDUCER

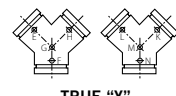

TRUE "Y"

### CAST FITTINGS

Tap Size Inches	Positions Y and V		Positions – Other	
	12" and below	14" and above	12" and below	14" and above
1/2	\$557.50	\$849.50	\$433.00	\$746.00
3/4	557.50	1132.50	523.50	799.50
1	657.50	1132.50	547.50	860.00
1 1/4	842.00	1320.50	567.00	930.00
1 1/2	947.00	1320.50	590.50	930.00
2	1011.00	1697.00	667.50	1008.50
2 1/2	2020.50	+	876.50	1172.00
3	2746.50	+	970.50	1336.50

**NOTE: Items listed in shaded areas are non-cancellable and non-returnable.**

+ Quoted on application. Contact Victaulic for pricing and availability.

## Elbows

Request publication 23.05.

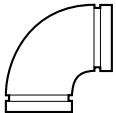

NO. 10-C



NO. 11-C

### ELBOWS – 90° ELBOW OR 45° ELBOW

Nom. Size Inches	Weight Each Lbs	90° Elbow No. 10-C		45° Elbow No. 11-C		
		Price Each		Weight Each Lbs	Price Each	
		Tnemoc 37-77	Cement Lined		Tnemoc 37-77	Cement Lined
3	8.6	\$224.50	\$235.50	5.8	\$192.00	\$201.00
4	12.0	233.50	245.00	8.4	247.50	260.00
6	22.0	375.00	393.00	15.0	356.00	374.00
8	38.0	579.50	608.50	28.8	533.00	558.50
10	76.0	961.50	1009.00	43.3	863.00	905.50
12	92.0	1376.00	1444.50	72.0	1256.50	1319.00
14	174.0	2512.00	2637.00	104.0	1983.00	2082.00
16	239.0	2976.00	3124.00	142.0	2545.50	2672.50
18	328.0	4114.00	4321.00	186.0	3357.50	3526.00
20	413.0	5295.50	5560.00	246.0	4345.50	4562.00
24	668.0	8211.50	8622.00	414.0	6532.00	6859.00
30	1002.0	14639.50	15371.50	720.0	12007.00	12607.00
36	1608.0	21855.50	22948.00	1152.0	18824.00	19765.00

**NOTE: Items listed in shaded areas are non-cancellable and non-returnable.**

+ Quoted on application. Contact Victaulic for pricing and availability.

**If domestic manufactured and/or ductile iron fittings are required, contact Victaulic for pricing and availability.**

All fittings ductile iron unless otherwise noted.

# Products for AWWA Grooved End Pipe

## Elbows

Request publication 23.05.



NO. 12-C



NO. 13-C

### ELBOWS – 22½° ELBOW OR 11¼° ELBOW

Nom. Size Inches	22½° Elbow No. 12-C			11¼° Elbow No. 13-C		
	Weight Each Lbs	Price Each		Weight Each (lbs)	Price Each	
		Tnemec 37-77	Cement Lined		Tnemec 37-77	Cement Lined
3	# 8.7	+	+	6.7	+	+
4	# 11.5	\$280.00	\$300.00	11.5	\$349.50	\$375.00
6	# 25.0	393.00	412.50	21.5	489.50	515.00
8	# 39.5	639.50	672.00	39.0	799.50	839.00
10	# 67.0	1245.50	1293.00	41.0	1456.50	1504.50
12	# 108.0	1708.50	1782.00	60.0	1864.00	1930.50
14	112.0	1933.50	2029.50	108.0	2024.50	2126.00
16	128.0	2638.00	2770.50	121.0	2638.00	2770.50
18	185.0	3554.50	3732.50	170.0	3554.50	3732.50
20	200.0	4655.50	4888.00	169.0	4655.50	4888.00
24	282.0	7015.50	7367.00	237.0	7015.50	7367.00
30	+	+	+	+	+	+
36	+	+	+	+	+	+

**NOTE: Items listed in shaded areas are non-cancellable and non-returnable.**

+ Quoted on application. Contact Victaulic for pricing and availability.

All fittings ductile iron unless otherwise noted.

**If domestic manufactured and/or ductile iron fittings are required, contact Victaulic for pricing and availability.**

# Cast Iron.

## Long Radius Elbows

### NO. 100-C

Request publication 23.05.

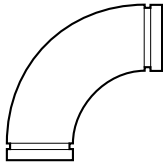

### 90° LONG RADIUS ELBOWS

Nom. Size Inches	Weight Each Lbs	Price Each †	
		Tnemec 37-77	Cement Lined
3	+	+	+
4	28.0	\$333.50	\$349.50
6	55.0	596.50	628.50
8	83.0	1081.50	1122.00
10	160.0	1806.00	1893.50
12	130.0	2293.00	2392.00
14	318.0	3786.00	3975.50
16	404.0	5017.00	5268.50
18	537.0	7095.50	7449.50
20	694.0	9140.50	9597.00
24	1090.0	14073.00	14778.00
30	+	+	+
36	+	+	+

**NOTE: Items listed in shaded areas are non-cancellable and non-returnable.**

+ Quoted on application. Contact Victaulic for pricing and availability.

† 45° Long Radius Elbow also available, priced on application. Contact Victaulic for pricing and availability.

All fittings ductile iron unless otherwise noted.

**If domestic manufactured and/or ductile iron fittings are required, contact Victaulic for pricing and availability.**

# Products for AWWA Grooved End Pipe

## Reducing Elbows

### NO. 10-CR

Request publication 23.05.

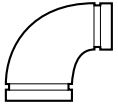

### REDUCING ELBOWS

Nominal Size	Weight Each	Price Each	
		Tnemec 37-77	Cement Lined
4 x 3	17.0	\$643.00	\$674.50
6 x 3	28.5	697.50	815.50
	# 29.6	610.50	642.00
8 x 4	# 46.5	754.50	791.50
	# 48.5	897.50	943.50
10 x 4	# 65.0	3714.50	3909.50
	# 77.0	1194.00	1253.00
	# 88.0	1393.50	1463.00
12 x 4	+	+	+
	6	90.0	2208.00
	8	98.0	2208.00
	10	102.0	2208.00
14 x 6	+	+	+
	8	135.0	2447.50
	10	170.0	2447.50
	12	195.0	2447.50
16 x 6	+	+	+
	8	+	+
	10	195.0	2879.50
	12	240.0	2879.50
	14	280.0	2879.50
18 x 6	+	+	+
	8	+	+
	10	+	+
	12	+	+
	14	+	+
	16	380.0	3891.00

Nominal Size	Weight Each	Price Each		
		Tnemec 37-77	Cement Lined	
20 x 6	+	+	+	
	8	+	+	
	10	+	+	
	12	+	+	
	14	405.0	\$5017.00	\$5280.50
	16	+	+	+
24 x 6	18	485.0	5017.00	5280.50
	8	+	+	+
	10	+	+	+
	12	+	+	+
	14	+	+	+
	16	+	+	+
	18	+	+	+
30 x 12	+	+	+	
	14	+	+	
	16	+	+	
	18	+	+	
	20	+	+	
	24	+	+	
36 x 12	+	+	+	
	14	+	+	
	16	+	+	
	18	+	+	
	20	+	+	
	24	+	+	
	30	+	+	

**NOTE: Items listed in shaded areas are non-cancellable and non-returnable.**

+ Quoted on application. Contact Victaulic for pricing and availability.

All fittings ductile iron unless otherwise noted.

**If domestic manufactured and/or ductile iron fittings are required, contact Victaulic for pricing and availability.**

# Cast Iron.

NOTE: Reducing base elbows are available. Contact Victaulic for pricing and availability.

# Products for AWWA Grooved End Pipe

## Tee or Lateral

Request publication 23.05.

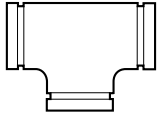

NO. 20-C

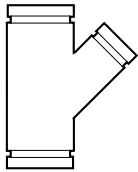

NO. 30-C

### TEE OR LATERAL

Nominal Size	Weight Each Lbs	Tee No. 20-C		45° Lateral No. 30-C		
		Price Each		Weight Each Lbs	Price Each	
		Tnemec 37-77	Cement Lined		Tnemec 37-77	Cement Lined
3	14.2	\$299.50	\$309.00	20.7	\$540.00	\$566.00
4	19.0	350.00	367.50	38.4	673.50	707.00
6	34.0	484.00	508.00	# 67.0	1148.50	1204.50
8	59.0	712.50	746.50	120.0	1359.50	1427.00
10	111.0	1415.00	1485.00	# 144.0	3102.00	3198.00
12	136.0	1980.00	2078.50	242.0	4362.00	4520.50
14	262.0	3430.50	3601.00	372.0	5657.50	5940.00
16	304.0	4479.50	4703.00	500.0	7346.50	7713.00
18	408.0	6187.50	6497.50	596.0	10057.00	10559.50
20	552.0	7563.00	7940.00	1103.0	13035.00	13686.50
24	980.0	13642.50	14241.00	1746.0	19365.50	20333.00
30	1552.0	23284.00	24447.50	+	+	+
36	2050.0	34213.50	35924.50	+	+	+

**NOTE: Items listed in shaded areas are non-cancellable and non-returnable.**

+ Quoted on application. Contact Victaulic for pricing and availability.

All fittings ductile iron unless otherwise noted.

**If domestic manufactured and/or ductile iron fittings are required, contact Victaulic for pricing and availability.**

# Cast Iron.

## Cap or Cross

Request publication 23.05.



NO. 60C

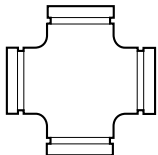

NO. 35-C

### CAP OR CROSS

Nominal Size	Weight Each Lbs	Cap # No. 60-C		Cross No. 35-C		
		Price Each		Weight Each Lbs	Price Each	
		Tnemec 37-77	Cement Lined		Tnemec 37-77	Cement Lined
3	3.0	\$132.00	\$138.50	+	+	+
4	5.0	132.00	138.50	40.0	\$769.50	\$807.50
6	9.0	196.50	205.00	71.0	1204.50	1265.00
8	16.0	276.50	289.00	106.0	1865.50	1959.50
10	37.2	440.50	462.50	120.0	2258.50	2371.50
12	52.0	600.00	632.50	158.0	3384.00	3553.50
14	52.0	951.50	998.00	307.0	4461.50	4684.50
16	68.0	1248.50	1311.00	426.0	5468.50	5742.00
18	90.0	1718.00	1803.50	562.0	7038.50	7390.00
20	110.0	2038.00	2139.50	+	+	+
24	165.0	3336.00	3502.00	+	+	+
30	300.0	4625.00	5535.00	+	+	+
36	536.0	7306.50	8376.00	+	+	+

**NOTE: Items listed in shaded areas are non-cancellable and non-returnable.**

+ Quoted on application. Contact Victaulic for pricing and availability.

All fittings ductile iron unless otherwise noted.

**If domestic manufactured and/or ductile iron fittings are required, contact Victaulic for pricing and availability.**

‡ Caps tapped pricing: ½ - ¾" \$173.50; 1" \$211.50; 1¼ - 1½" \$278.50; 2" \$335.00; 2½" \$409.50; 3" \$461.50

§ All caps with taps are non-cancellable and non-returnable.



# Products for AWWA Grooved End Pipe

## Reducing Tees

### NO. 25-C

Request publication 23.05.

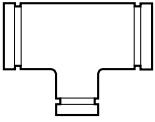

NO. 25-C

### REDUCING TEES

Nominal Size	Weight Each	Price Each	
		Tnemec 37-77	Cement Lined
4 x 3	# 26.4	\$333.00	\$349.00
6 x 3	53.0	459.00	482.00
4	46.0	459.00	482.00
8 x 4	# 78.0	676.00	709.50
6	# 80.0	676.00	709.50
10 x 4	120.0	1344.00	1412.00
6	128.0	1344.00	1412.00
8	130.0	1344.00	1412.00
12 x 4	112.0	1880.50	1975.50
6	180.0	1880.50	1975.50
8	186.0	1880.50	1975.50
10	192.0	1880.50	1975.50
14 x 6	238.0	3377.50	3546.50
8	241.0	3377.50	3546.50
10	310.0	3377.50	3546.50
12	328.0	3377.50	3546.50
16 x 6	268.0	4256.00	4468.00
8	290.0	4256.00	4468.00
10	319.0	4256.00	4468.00
12	330.0	4256.00	4468.00
14	341.0	4256.00	4468.00
18 x 6	320.0	5878.00	6171.50
8	326.0	5878.00	6171.50
10	332.0	5878.00	6171.50
12	339.0	5878.00	6171.50
14	441.0	5878.00	6171.50
16	453.0	5878.00	6171.50

Nominal Size	Weight Each	Price Each	
		Tnemec 37-77	Cement Lined
20 x 6	405.0	\$7185.00	\$7544.00
8	412.0	7185.00	7544.00
10	419.0	7185.00	7544.00
12	426.0	7185.00	7544.00
14	443.0	7185.00	7544.00
16	571.0	7185.00	7544.00
18	584.0	7185.00	7544.00
24 x 6	570.0	12884.50	13528.50
8	578.0	12884.50	13528.50
10	586.0	12884.50	13528.50
12	593.0	12884.50	13528.50
14	610.0	12884.50	13528.50
16	620.0	12884.50	13528.50
18	918.0	12884.50	13528.50
20	937.0	12884.50	13528.50
30 x 12	1175.0	23563.00	24741.50
14	1250.0	23563.00	24741.50
16	1437.0	23563.00	24741.50
18	1450.0	23563.00	24741.50
20	1462.0	23563.00	24741.50
24	1475.0	23563.00	24741.50
36 x 12	+	33603.00	35281.50
14	+	+	+
16	+	+	+
18	+	+	+
20	+	+	+
24	+	33603.00	35281.50
30	+	33603.00	35281.50

**NOTE: Items listed in shaded areas are non-cancellable and non-returnable.**

**If domestic manufactured and/or ductile iron fittings are required, contact Victaulic for pricing and availability.**

All fittings ductile iron unless otherwise noted.

+ Quoted on application. Contact Victaulic for pricing and availability.

# Cast Iron.

# Products for AWWA Grooved End Pipe

## Reducing Fittings

Request publication 23.05.

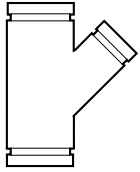

NO. 30-CR  
REDUCING LATERAL

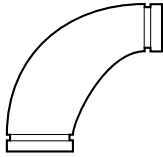

NO. 100-CR  
90° LONG RADIUS REDUCING ELBOW

### REDUCING FITTINGS – REDUCING LATERAL OR 90° LONG RADIUS REDUCING ELBOW

Nominal Size	Reducing Lateral No. 30-CR				90° Long Radius Reducing Elbow No. 100-CR †		
	Inches	Wgt. Ea. Lbs	Price Each		Wgt. Ea. Lbs	Price Each	
			Tnemec 37-77	Cement Lined		Tnemec 37-77	Cement Lined
4 x 3	45.0	\$630.50	\$686.50	+	+	+	
6 x 3	74.0	1074.50	1112.50	+	+	+	
6 x 4	80.0	1074.50	1112.50	+	+	+	
8 x 4	125.0	1592.00	1649.50	+	+	+	
8 x 6	140.0	1592.00	1649.50	+	+	+	
10 x 4	204.0	2035.00	2173.00	+	+	+	
10 x 6	212.0	2035.00	2173.00	+	+	+	
10 x 8	236.0	2035.00	2173.00	+	+	+	
12 x 4	290.0	4085.50	4234.00	+	+	+	
12 x 6	302.0	4085.50	4234.00	+	+	+	
12 x 8	324.0	4085.50	4234.00	+	+	+	
12 x 10	356.0	4085.50	4234.00	+	+	+	
14 x 6	330.0	5497.00	5772.50	+	+	+	
14 x 8	346.0	5497.00	5772.50	+	+	+	
14 x 10	+	+	+	+	+	+	
14 x 12	+	+	+	+	+	+	
16 x 6	+	+	+	+	+	+	
16 x 8	+	+	+	+	+	+	
16 x 10	+	+	+	+	+	+	
16 x 12	+	+	+	+	+	+	
16 x 14	+	+	+	+	+	+	
18 x 6	+	+	+	+	+	+	
18 x 8	+	+	+	+	+	+	
18 x 10	+	+	+	+	+	+	
18 x 12	+	+	+	+	+	+	
18 x 14	+	+	+	+	+	+	
18 x 16	+	+	+	+	+	+	
20 x 6	+	+	+	+	+	+	
20 x 8	+	+	+	+	+	+	
20 x 10	+	+	+	+	+	+	
20 x 12	+	+	+	+	+	+	
20 x 14	+	+	+	+	+	+	
20 x 16	+	+	+	+	+	+	
20 x 18	+	+	+	+	+	+	
24 x 6	+	+	+	+	+	+	
24 x 8	+	+	+	+	+	+	
24 x 10	+	+	+	+	+	+	
24 x 12	+	+	+	+	+	+	
24 x 14	+	+	+	+	+	+	
24 x 16	1651.1	19185.00	20151.50	+	+	+	
24 x 18	910.2	19185.00	20151.50	+	+	+	
24 x 20	+	+	+	+	+	+	

**NOTE: Items listed in shaded areas are non-cancellable and non-returnable.**

+ Quoted on application. Contact Victaulic for pricing and availability.

† Long radius reducing base 90° elbows are available. Contact Victaulic for pricing and availability.

**If domestic manufactured and/or ductile iron fittings are required, contact Victaulic for pricing and availability.**

# Products for AWWA Grooved End Pipe

## Reducing Fittings

Request publication 23.05.

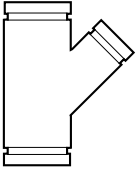

NO. 30-CR  
REDUCING LATERAL

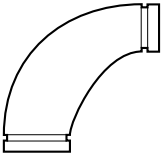

NO. 100-CR  
90° LONG RADIUS REDUCING ELBOW

### REDUCING FITTINGS – REDUCING LATERAL OR 90° LONG RADIUS REDUCING ELBOW

Nominal Size		Reducing Lateral No. 30-CR			90° Long Radius Reducing Elbow No. 100-CR †		
		Wgt. Ea. Lbs	Price Each		Wgt. Ea. Lbs	Price Each	
Inches	Tnemec 37-77		Cement Lined	Tnemec 37-77		Cement Lined	
30	x	12	+	+	+	+	+
		14	+	+	+	+	+
		16	+	+	+	+	+
		18	+	+	+	+	+
		20	+	+	+	+	+
		24	+	+	+	+	+
36	x	12	+	+	+	+	+
		14	+	+	+	+	+
		16	+	+	+	+	+
		18	+	+	+	+	+
		20	+	+	+	+	+
		24	+	+	+	+	+
		30	+	+	+	+	+

**NOTE: Items listed in shaded areas are non-cancellable and non-returnable.**

+ Quoted on application. Contact Victaulic for pricing and availability.

† Long radius reducing base 90° elbows are available. Contact Victaulic for pricing and availability.

**If domestic manufactured and/or ductile iron fittings are required, contact Victaulic for pricing and availability.**

# Products for AWWA Grooved End Pipe

## Reducing Fittings

Request publication 23.05.

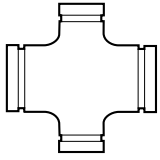

NO. 35-CR  
REDUCING  
CROSS

### REDUCING FITTINGS – REDUCING CROSS

Nominal Size		Reducing Cross No. 35-CR		
Inches		Wgt. Ea. Lbs.	Price Each	
			Tnemec 37-77	Cement Lined
4	x 3	+	+	+
6	x 3	+	+	+
		4	+	+
8	x 4	+	+	+
		6	+	+
10	x 4	+	+	+
		6	+	+
		8	+	+
12	x 4	+	+	+
		6	+	+
		8	+	+
		10	+	+
14	x 6	+	+	+
		8	+	+
		10	+	+
		12	+	+
16	x 6	+	+	+
		8	+	+
		10	+	+
		12	+	+
		14	+	+
18	x 6	+	+	+
		8	+	+
		10	+	+
		12	+	+
		14	+	+
16	+	+	+	

Nominal Size		Reducing Cross No. 35-CR		
Inches		Wgt. Ea. Lbs.	Price Each	
			Tnemec 37-77	Cement Lined
20	x 6	+	+	+
		8	+	+
		10	+	+
		12	+	+
		14	+	+
		16	+	+
24	x 6	+	+	+
		8	+	+
		10	+	+
		12	+	+
		14	+	+
		16	+	+
		18	+	+
30	x 12	+	+	+
		14	+	+
		16	+	+
		18	+	+
		20	+	+
		24	+	+
36	x 12	+	+	+
		14	+	+
		16	+	+
		18	+	+
		20	+	+
		24	+	+
30	+	+	+	

**NOTE: Items listed in shaded areas are non-cancellable and non-returnable.**

+ Quoted on application. Contact Victaulic for pricing and availability.

NOTE: Non standard reducing crosses are available. Contact Victaulic for pricing and availability.

**If domestic manufactured and/or ductile iron fittings are required, contact Victaulic for pricing and availability.**

# Products for AWWA Grooved End Pipe

## Concentric Reducer

### NO. 50-C

Request publication 23.05.

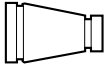

NO. 50-C

### CONCENTRIC REDUCER

Nominal Size		Weight Each	Price Each	
Inches	Lbs		Tnemec 37-77	Cement Lined
4 x 3	# 10.0		\$336.50	\$353.50
	15.0		489.50	507.50
6 x 4	# 16.5		489.50	507.50
	+		+	+
	# 28.0		607.00	637.50
8 x 4	# 34.0		607.00	637.50
	# 42.0		918.00	965.00
	# 46.0		918.00	965.00
10 x 4	# 50.0		918.00	965.00
	# 60.0		1339.50	1408.50
	# 70.0		1339.50	1408.50
12 x 4	# 74.0		1339.50	1408.50
	# 84.0		1339.50	1408.50
	89.0		2164.00	2272.50
14 x 6	102.0		2164.00	2272.50
	112.0		2164.00	2272.50
	126.0		2164.00	2272.50
	+		+	+
16 x 6	122.0		3312.50	3458.50
	135.0		3312.50	3458.50
	146.0		3312.50	3458.50
	173.0		3312.50	3458.50
	+		+	+
18 x 6	+		+	+
	+		+	+
	158.0		4542.00	4769.00

Nominal Size		Weight Each	Price Each	
Inches	Lbs		Tnemec 37-77	Cement Lined
18 x 12	173.0		\$4542.00	\$4769.00
	200.0		4542.00	4769.00
	220.0		4542.00	4769.00
20 x 6	+		+	+
	173.0		5555.00	5832.00
	182.0		5555.00	5832.00
	201.0		5555.00	5832.00
	230.0		5555.00	5832.00
	251.0		5555.00	5832.00
	275.0		5555.00	5832.00
24 x 6	+		+	+
	+		+	+
	+		+	+
	293.0		8204.00	8614.50
	331.0		8204.00	8614.50
	358.0		8204.00	8614.50
	386.0		8204.00	8614.50
	418.0		8204.00	8614.50
30 x 18	+		+	+
	693.0		10802.50	11343.50
	770.0		10802.50	11343.50
	1280.0		16100.00	17154.00
36 x 24	1370.0		16100.00	17154.00
	+		16100.00	17154.00
	+		16100.00	17154.00

**NOTE: Items listed in shaded areas are non-cancellable and non-returnable.**

+ Quoted on application. Contact Victaulic for pricing and availability.

All fittings ductile iron unless otherwise noted.

**If domestic manufactured and/or ductile iron fittings are required, contact Victaulic for pricing and availability.**

# Cast Iron.



# Products for AWWA Grooved End Pipe

## Eccentric Reducers

### NO. 51-C

Request publication 23.05.

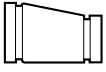

NO. 51-C

### ECENTRIC REDUCERS

Nominal Size		Weight Each	Price Each	
Inches	Lbs		Tnemec 37-77	Cement Lined
4	x 3	12.0	\$417.00	\$439.50
	x 4	25.0	519.00	546.50
8	x 4	35.0	754.50	792.00
	x 6	44.0	754.50	792.00
10	x 4	54.0	1144.50	1203.00
	x 6	60.0	1144.50	1203.00
	x 8	70.0	1144.50	1203.00
12	x 4	82.0	1666.00	1749.50
	x 6	84.0	1666.00	1749.50
	x 8	91.0	1666.00	1749.50
	x 10	110.0	1666.00	1749.50
14	x 6	+	+	+
	x 8	+	+	+
	x 10	135.0	2165.00	2272.50
	x 12	150.0	2165.00	2272.50
16	x 6	+	+	+
	x 8	+	+	+
	x 10	168.0	3312.00	3458.50
	x 12	190.0	3312.00	3458.50
	x 14	+	+	+

Nominal Size		Weight Each	Price Each	
Inches	Lbs		Tnemec 37-77	Cement Lined
18	x 8	+	+	+
	x 10	+	+	+
	x 12	+	+	+
	x 14	+	+	+
	x 16	+	+	+
20	x 10	+	+	+
	x 12	250.0	\$5556.50	\$5832.00
	x 14	270.0	5556.50	5832.00
	x 16	300.0	5556.50	5832.00
	x 18	+	+	+
24	x 12	+	+	+
	x 14	+	+	+
	x 16	+	+	+
	x 18	465.0	8648.50	9041.50
	x 20	+	+	+
30	x 18	+	+	+
	x 20	+	+	+
	x 24	+	10802.50	11343.50
36	x 20	+	+	+
	x 24	+	+	+
	x 30	+	+	+

**NOTE: Items listed in shaded areas are non-cancellable and non-returnable.**

+ Quoted on application. Contact Victaulic for pricing and availability.

All No. 51-C fittings are globally sourced ductile iron.

**If domestic manufactured and/or ductile iron fittings are required, contact Victaulic for pricing and availability.**

# Products for AWWA Grooved End Pipe

## Bullhead Tee

### NO. 21-C

Request publication 23.05.

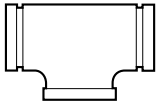

NO. 21-C

### BULLHEAD TEE

Nominal Size	Weight Each	Price Each	
		Tnemec 37-77	Cement Lined
4 x 4 x 6	# 65.0	+	+
6 x 6 x 8	# 100.0	+	+
8 x 8 x 10	# 185.0	+	+
10 x 10 x 12	# 250.0	+	+

**NOTE: Items listed in shaded areas are non-cancellable and non-returnable.**

+ Quoted on application. Contact Victaulic for pricing and availability.

# Cast Iron.

## True Wye

### NO. 33-C

Request publication 23.05.

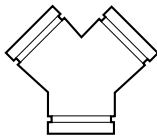

NO. 33-C

### TRUE WYE

Nominal Size	Weight Each	Price Each	
		Tnemec 37-77	Cement Lined
3	# 25.0	\$1237.50	\$1267.50
4	# 35.0	2206.00	2301.50
6	# 60.0	2893.50	3037.50
8	# 90.0	3978.00	4176.50
10	141.0	+	+
12	195.0	+	+
14	+	+	+
16	+	+	+
18	+	+	+
20	+	+	+
24	+	+	+
30	+	+	+
36	+	+	+

**NOTE: Items listed in shaded areas are non-cancellable and non-returnable.**

+ Quoted on application. Contact Victaulic for pricing and availability.

**If domestic manufactured and/or ductile iron fittings are required, contact Victaulic for pricing and availability.**

# Cast Iron.

## Base Fittings

Request publication 23.05.

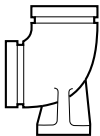

NO. 10-CB  
90° BASE ELBOW

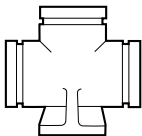

NO. 20-CB  
BASE TEE

### BASE FITTINGS – 90° BASE ELBOW OR BASE TEE

Nom. Size	90° Base Elbow No. 10-CB			Base Tee No. 20-CB		
	Weight Each Lbs	Price Each		Weight Each Lbs	Price Each	
Tnemec 37-77		Cement Lined	Tnemec 37-77		Cement Lined	
3	19.0	\$1365.00	\$1432.50	19.0	+	+
4	23.6	408.50	428.50	26.0	+	+
6	42.0	693.50	728.00	50.0	+	+
8	75.0	917.50	963.00	92.0	+	+
10	114.0	1473.00	1547.00	115.0	+	+
12	152.0	2117.50	2223.50	181.0	+	+
14	295.0	3917.50	4113.00	293.0	+	+
16	312.0	4847.50	5155.00	338.0	+	+
18	451.0	5765.50	6053.50	489.0	+	+
20	557.0	7847.00	8240.00	632.0	+	+
24	875.0	11155.50	11572.00	895.0	+	+
30	+	+	+	+	+	+
36	+	+	+	+	+	+

**NOTE: Items listed in shaded areas are non-cancellable and non-returnable.**

+ Quoted on application. Contact Victaulic for pricing and availability.

All fittings ductile iron unless otherwise noted.

**If domestic manufactured and/or ductile iron fittings are required, contact Victaulic for pricing and availability.**

Side base fittings are available. Contact Victaulic for pricing and availability.

# Products for AWWA Grooved End Pipe

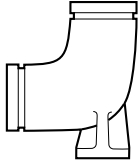

NO. 100-CB  
90° BASE LONG RADIUS ELBOW

## BASE FITTINGS – 90° BASE LONG RADIUS ELBOW

Nom. Size	90° Base Long Rad. Elbow No. 100-CB		
	Weight Each Lbs	Price Each	
		Tnemec 37-77	Cement Lined
3	25.0	+	+
4	40.0	\$1699.50	\$1862.50
6	76.0	2401.50	2528.00
8	141.0	4004.50	4214.50
10	206.0	5759.00	6335.00
12	310.0	6090.50	6409.50
14	340.0	7080.50	7457.00
16	425.0	9345.50	9837.50
18	591.0	11700.00	12315.00
20	717.0	14395.00	15153.00
24	1056.0	18650.00	19632.50
30	+	+	+
36	+	+	+

**NOTE: Items listed in shaded areas are non-cancellable and non-returnable.**

+ Quoted on application. Contact Victaulic for pricing and availability.

All fittings ductile iron unless otherwise noted.

**If domestic manufactured and/or ductile iron fittings are required, contact Victaulic for pricing and availability.**

Side base fittings are available. Contact Victaulic for pricing and availability.

# Products for AWWA Grooved End Pipe

## Reducing Base Tees

### NO. 25-CB

Request publication 23.05.

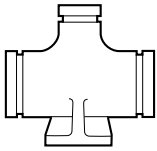

NO. 25-CB

### REDUCING BASE TEES

Nominal Size	Wgt. Ea.	Price Each	
		Tnemec 37-77	Cement Lined
4 x 3	60.0	\$1860.00	\$1957.50
6 x 3	91.0	+	+
4	90.0	1976.00	2080.00
8 x 4	162.0	3021.00	3180.00
6	163.0	3021.00	3180.00
10 x 4	225.0	3741.50	3913.50
6	231.0	3741.50	3913.50
8	231.0	3741.50	3913.50
12 x 4	312.0	4613.00	4856.00
6	313.0	4613.00	4856.00
8	318.0	4613.00	4856.00
10	358.0	4613.00	4856.00
14 x 6	+	+	+
8	+	+	+
10	+	+	+
12	+	+	+
16 x 6	+	+	+
8	+	+	+
10	+	+	+
12	+	+	+
14	+	+	+
18 x 6	+	+	+
8	+	+	+
10	+	+	+
12	+	+	+
14	+	+	+
16	+	+	+

Nominal Size	Wgt. Ea.	Price Each	
		Tnemec 37-77	Cement Lined
20 x 6	+	+	+
8	+	+	+
10	+	+	+
12	+	+	+
14	+	+	+
16	+	+	+
18	+	+	+
24 x 6	+	+	+
8	+	+	+
10	+	+	+
12	+	+	+
14	+	+	+
16	+	+	+
18	+	+	+
20	+	+	+
30 x 12	+	+	+
14	+	+	+
16	+	+	+
18	+	+	+
20	+	+	+
24	+	+	+
36 x 12	+	+	+
14	+	+	+
16	+	+	+
18	+	+	+
20	+	+	+
24	+	+	+
30	+	+	+

**NOTE: Items listed in shaded areas are non-cancellable and non-returnable.**

+ Quoted on application. Contact Victaulic for pricing and availability.

All fittings ductile iron unless otherwise noted.

**If domestic manufactured and/or ductile iron fittings are required, contact Victaulic for pricing and availability.**

Side base fittings are available. Contact Victaulic for pricing and availability.

# Products for AWWA Grooved End Pipe

## Flares and Outlets

Request publication 23.05.

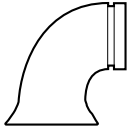

NO. 10-CF 90° FLARE

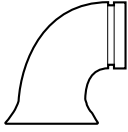

NO. 100-CF 90° LONG RADIUS FLARE

### FLARES – 90° FLARE OR 90° LONG RADIUS FLARE

Nominal Size	90° Flare No. 10-CF			90° Long Rad. Flare No. 100-CF		
	Weight Each Lbs	Price Each		Weight Each Lbs	Price Each	
		Tnemec 37-77	Cement Lined		Tnemec 37-77	Cement Lined
3	# 18.0	\$871.50	\$914.50	# 23.0	+	+
4	# 35.0	1045.00	1096.50	# 42.0	+	+
6	# 70.0	1325.50	1391.50	# 68.0	+	+
8	# 120.0	2400.00	2499.50	# 118.0	+	+
10	# 157.0	3736.00	3923.00	# 188.0	+	+
12	# 190.0	5694.00	5961.00	# 275.0	+	+
14	# 235.0	+	+	+	+	+
18	+	+	+	+	+	+
20	+	+	+	+	+	+
24	+	+	+	+	+	+
30	+	+	+	+	+	+
36	+	+	+	+	+	+

**NOTE: Items listed in shaded areas are non-cancellable and non-returnable.**

+ Quoted on application. Contact Victaulic for pricing and availability.

# Cast Iron.

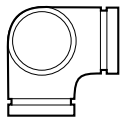

NO. 10-CS 90° SIDE OUTLET

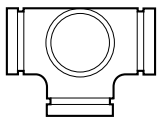

NO. 20-CS TEE SIDE OUTLET

### FLARES AND OUTLETS – 90° SIDE OUTLET OR TEE SIDE OUTLET

Nom. Size	90° Side Outlet No. 10-CS †			Tee Side Outlet No. 20-CS †		
	Weight Each Lbs	Price Each		Weight Each Lbs	Price Each	
		Tnemec 37-77	Cement Lined		Tnemec 37-77	Cement Lined
3	13.0	+	+	28.0	+	+
4	30.0	+	+	42.0	+	+
6	58.0	+	+	85.0	+	+
8	90.0	+	+	114.0	+	+
10	124.0	+	+	219.0	+	+
12	170.0	+	+	295.0	+	+
14	+	+	+	+	+	+
16	+	+	+	+	+	+
18	+	+	+	+	+	+
20	+	+	+	+	+	+
24	+	+	+	+	+	+
30	+	+	+	+	+	+
36	+	+	+	+	+	+

† Reducing side outlet tees and reducing 90° side outlets are available. Contact Victaulic for pricing and availability.

**NOTE: Items listed in shaded areas are non-cancellable and non-returnable.**

+ Quoted on application. Contact Victaulic for pricing and availability.

# Products for AWWA Grooved End Pipe

## Flares and Outlets

Request publication 23.05.



NO. 43-CF STRAIGHT FLARE

### STRAIGHT FLARE

Nom. Size Inches	Weight Each Lbs	Straight Flare - No. 43-CF	
		Price Each	
		Tnemec 37-77	Cement Lined
3 x 8	# 13.0	\$907.50	\$955.50
4 x 8	# 17.0	907.50	955.50
6 x 8	# 23.0	1282.00	1349.50
8 x 10	# 43.0	1481.50	1559.00
10 x 10	# 58.0	2117.00	2232.50
12 x 12	# 90.0	2879.50	3031.50
14 x 12	160.0	+	+
16 x 16	+	+	+
18 x 16	+	+	+
20 x 18	+	+	+
24 x 18	+	+	+
30 x 24	+	+	+
36 x 24	+	+	+

**NOTE: Items listed in shaded areas are non-cancellable and non-returnable.**

+ Quoted on application. Contact Victaulic for pricing and availability.

# Cast Iron.

---

# Pipe Preparation Tools



## LEASE PURCHASE AGREEMENT

Some tools manufactured by Victaulic are available through a lease purchase agreement. Contact Victaulic for details.

# Pipe Preparation Tools

## Cut Grooving Tools

**Notice:** When ordering a cut grooving tool, please specify standard steel or ductile iron (rigid or flexible).

### VG28GD (Gear Drive) \*

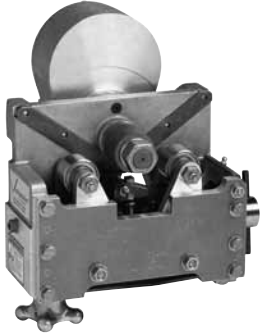

Includes tool set for grooving 4 – 6” standard steel pipe, crate, operating instructions, tool bit removal kit, 10” extension bar, depth stop adjustment tools, and one extra 2 – 3½” and 8” standard groove steel pipe tool bits.

**Capacities:** 2 – 8” steel (and other IPS) and 3 – 6” cast and ductile pipe (Additional bits required)

Tool Model	Part Number	Tool Weight/ Shipping Weight Lbs	Rental Per Month	Tool List Price
VG28GD (Gear Drive)	R000281AVG	37/56	\$1949.00	<b>\$15888.50</b>

\* NOTE: Victaulic Cut Grooving Tools require an external power source (see Power Mule in Pipe Preparation Tool Accessories).

#### VG28GD RATINGS

Pipe Material	Pipe Size/Schedule							
	2 50	2½ 65	3 80	3½ 90	4 100	5 125	6 150	8 200
Ductile Iron	Class 53 Min.							

\* 6”/150 mm Schedule 8

#### VG28GD PARTS

Type Pipe	Type Groove	Pipe Size/ Tool Bit Marking	Part Numbers	Purchase Price Each
AWWA # Cast and Ductile Iron	Standard (Rigid)	3 – 6” CIR *	RK03280G06	<b>\$535.50</b>
	Flexible	3 – 6” CIF	RK03280E06	<b>\$35.50</b>

# Carbide Tipped Tool Bits supplied for grooving cast and ductile pipe have one edge **not** suitable for resharpening.

\* Requires Special Cast Iron Rigid Pipe Stops (Part No. R-016-280-AVG [2 required]).

NOTE: Special urethane covered Idler Roll (Part No. R-033-281-AVG) recommended for grooving glass lined pipe.

Thoroughly Read and Understand All Operating and Maintenance Instructions Before Attempting to Use any Victaulic Pipe Preparation Tools.



# Pipe Preparation Tools

## VG824 \*

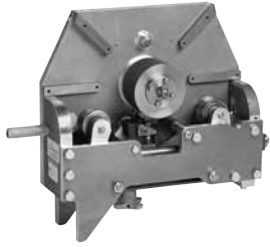

Includes tool set for grooving 8 – 12" standard steel pipe, crate, operating instructions, tool bit removal kit, wrench and one extra 8 – 24" standard groove steel pipe tool bit.

**Capacities:** 8 – 24" steel (and other IPS) and 8 – 24" cast and ductile pipe (Additional bits required)

Note: Tools bits and stops for D.I. are optional. See below.

Tool Model	Part Number	Tool Weight/ Shipping Weight Lbs	Rental Per Month	Total List Price
VG824	R000824AVG	82/126	\$2730.00	<b>\$29588.50</b>

\* NOTE: Victaulic Cut Grooving Tools require an external power source (see Power Mule in Pipe Preparation Tool Accessories).

### VG824 RATINGS

Pipe Material	Pipe Size/Wall Thickness									
	8 200	10 250	12 300	14 350	16 400	18 450	20 500	22 550	24 600	
Ductile Iron	Class 53 Min.									

### VG824 PARTS

Type Pipe	Type Groove	Tool Bit			Pipe Stop		
		Pipe/Size Marking	Part Numbers	Purchase Price Each	Pipe/Size Marking	Part Numbers	Purchase Price Each
AWWA # Cast and Ductile Iron	Std. (Rigid)	8" CIR	RK08824G08	<b>\$325.50</b>	8" CI	R524824AVG	<b>\$575.00</b>
		10 – 12" CIR	RK10824G12	<b>325.50</b>	10 – 12" CI	R024824AVG	<b>575.00</b>
		14" CIR	RK14824G14	<b>325.50</b>	14" CI	R224824AVG	<b>575.00</b>
		16 – 24" CIR	RK16824G24	<b>325.50</b>	16 – 24" CI	R324824AVG	<b>575.00</b>
	Flexible	8 – 12" CIF	RK08824E12	<b>325.50</b>	8" CI	R524824AVG	<b>575.00</b>
		14 – 24" CIF	RK14824E24	<b>325.50</b>	10 – 12" CI	R024824AVG	<b>575.00</b>

# Carbide Tipped Tool Bits supplied for grooving cast and ductile pipe have one edge **not** suitable for resharpening.

NOTE: Special urethane covered Idler Roll (Part No. R-201-824-AVG) recommended for grooving glass lined pipe. Center adjustable stop (Part. No. R-025-824-AVG) available.

Thoroughly Read and Understand All Operating and Maintenance Instructions Before Attempting to Use any Victaulic Pipe Preparation Tools.

# Pipe Preparation Tools

## VG412 Orbital Grooving Tool



Includes riser blocks and grooving heads for cut grooving 4 – 12" ductile iron rigid groove. Power drive supplied requires 120 volt, 11.5 amp electrical supply. Stand included at no extra charge.

**Capacities:** 4 – 12" ductile iron pipe

Note: Tools bits and stops for D.I. are optional. See below.

Tool Model	Part Number	Tool Weight/ Shipping Weight Lbs	Rental Per Month	List Price
VG412 Orbital Grooving Tool	R000412AVG	270/365	\$2921.00	<b>\$34888.00</b>
IPS Steel kit for cutting and grooving* (recommended only for lined steel pipe)	N003412034	–	588.00	<b>5763.00</b>
Optional flexible spacer blocks: 4 – 6" / 114.3 x 168.3 mm	N220412667	–	–	<b>204.00</b>
8" / 219.1 mm	N220412668	–	–	<b>220.00</b>
10 – 12" / 273.0 — 323.9	N220412669	–	–	<b>227.50</b>

\* NOTE: Steel grooving kit can only be rented with rental tool.

### VG412 RATINGS

Pipe Material	Pipe Size/Wall Thickness						
	4 100	4½ 120	5 125	6 150	8 200	10 250	12 300
Ductile Iron	Class 53 Min.						

### VG412 PARTS

Type Pipe	Knife Style	Pipe Size Tool Bit Marking	Part Numbers	Purchase Price Each
AWWA Cast and Ductile Iron #	Straight	4 – 6	N220412680	<b>\$357.50</b>
	Angled	4 – 6	N220412568	<b>357.50</b>
	Straight	8 – 12	N220412679	<b>357.50</b>
	Angled	8 – 12	N220412569	<b>357.50</b>
	Solid Cut-Off Blade			N275412055

# Carbide Tipped Tool Bits supplied for grooving cast and ductile pipe have one edge **not** suitable for resharpening.

## VG



Vic-Groovers are designed for cut grooving a single size on standard size steel pipe. Vic-Groovers are supplied with an extra tool bit and ratchet handle. 2" and larger tools include a power yoke. Power yoke is available for ¾ and 1" (Part. No. R0240030VG), 1¼ and 1½" (Part No. R0240050VG) tools at **\$169.50** additional.

NOTE: Vic-Groovers not recommended for use with a hand-held power drive.

Size	VG Tool for Cast Pipe (Gray and Ductile)				
Inches	Style	OD	Weight	Part Number	Price
3	Rigid	3.960	20.0	R00R015CVG	<b>\$3309.50</b>
3	Flexible	3.960	20.0	R00F015CVG	<b>3309.50</b>
4	Rigid	4.800	26.0	R00R019CVG	<b>3309.50</b>
4	Flexible	4.800	26.0	R00F019CVG	<b>3309.50</b>
6	Rigid	6.900	27.0	R00R027CVG	<b>3309.50</b>
6	Flexible	6.900	27.0	R00F027CVG	<b>3309.50</b>
8	Rigid	9.050	40.0	R00R036CVG	<b>5213.50</b>
8	Flexible	9.050	40.0	R00F036CVG	<b>5213.50</b>

### VG RATINGS

Pipe Material	Pipe Size/Wall Thickness			
	4	5	6	8
Ductile Iron	Class 53 Min.			Class 53 Min.

Thoroughly Read and Understand All Operating and Maintenance Instructions Before Attempting to Use any Victaulic Pipe Preparation Tools.

# Pipe Preparation Tools

## PT-100-A Go/No-Go Grooved Pipe Diameter Tape



Pocket-sized steel tapes are available for taking circumferential measurements on pipe sizes  $\frac{3}{4}$  – 24". This diameter tape contains Go/No-Go markings on one side for use with ANSI B36.19 and many ISO-4200 pipe sizes, and diameter markings to 100th of an inch on the other side. Tapes are notched on the lead end to allow proper overlap within the groove for more accurate measurement.

Tool Model	Part Number	Purchase Price
PT-100-A/PT-101 Go/No-Go Grooved Pipe Diameter Tape Each	RW75-100-MCH	<b>\$58.50</b>
Box of 6	RW75-100-KIT	<b>322.00</b>

### NOTICE

- Tape contains Go/No-Go markings on one side for use with  $\frac{3}{4}$  – 24" pipe in ANSI B36.19 and many ISO-4200 sizes and is marked in 1/100th of an inch increments on the other side.
- The Go/No-Go side can be used to check cut or roll grooved pipe conformance to Victaulic original and Machined for Rubber Lining (MRL) ( $\frac{3}{4}$  – 12") and Advanced Groove System (AGS) (14 – 24") groove diameter specifications.
- Tapes are notched on the lead end to allow proper overlap within the groove for more accurate measurement.
- The Go/No-Go side of the tape is not intended for use on sizes 76.1; 139.7; 165.1; 165.2; 216.3; 267.4; and 318.5 mm steel or stainless steel pipe sizes. For cast or ductile iron pipe sizes (up to 20"), copper tube sizes, and the steel and stainless steel pipe sizes listed above, use the side of the tape marked in 0.01" increments.
- The Go/No-Go pipe tape is a quick reference guide only. To ensure proper grooving dimensions, always refer to the I-100 Victaulic Field Installation Handbook or to the latest groove specifications publications located on [www.victaulic.com](http://www.victaulic.com).

Thoroughly Read and Understand All Operating and Maintenance Instructions Before Attempting to Use any Victaulic Pipe Preparation Tools.

# Pipe Preparation Tools

---

## TERMS AND CONDITIONS OF TOOL RENTAL

1. Lessor rents to Lessee and Lessee leases from Lessor the tool(s) and accessories listed on the reverse side hereof, which are designed for use in the preparation of pipe to receive Victaulic products, hereinafter called the leased property; for the term specified, commencing when the leased property is delivered to carrier for delivery to Lessee.
2. **Rental Rate.** Lessee agrees to pay rent at the rates specified on this agreement. The rental shall be due and payable at the end of each month during the term of the lease. Terms of payment: net 30 days from date of invoice. If lease is terminated any time during the initial month, the rental shall be payable at the then current published monthly rental rate. If lease is terminated any time during a subsequent month, the rental will be prorated. (This agreement is valid for one (1) year, at the time of signing. It will be automatically renewed with price in effect at the time of renewal until the signee terminates the agreement.)
3. **On-Account Payment.** Lessee, on executing the agreement, has made an on-account payment to Lessor which shall be returned to Lessee upon termination of the lease, or applied to any open invoices on the Lessee's account, provided Lessee is not in default under any of the term of the lease and has returned leased property in good condition, less ordinary wear and tear.
4. **Freight.** Outbound: F.O.B. Shipping Point (Our Option) – Freight Collect. Return: Lessee shall pay all shipping charges for return of the leased property.
5. **Use.** All leased property is for the exclusive use of Lessee only, and may not be assigned, transferred, sublet or loaned to or used by any other party, without prior written consent of the Lessor.
6. **Ownership.** The property leased is and shall at all times remain the sole property of the Lessor, and Lessee shall have no right, title or interest therein except as expressly set forth in this Lease.
7. **Taxes.** Lessee shall pay all taxes, assessments, license and registration fees levied on the leased property while in the Lessee's possession and Lessee shall keep the leased property free and clear of all liens and encumbrances. Lessee shall pay all sales taxes invoiced by Victaulic Company unless the lessee provides the lessor with a valid sales tax exemption certificate for the state where the tool is delivered.
8. **Access.** Lessor shall at all times have free access to the leased property and to the premises on which located, for the purpose of examining the leased property.
9. **Return of Property.** Lessee shall return all leased property, properly crated, freight prepaid, and insured for its market value to Lessor at one of the locations indicated on the back cover. If Lessee fails to return the leased property upon termination, Lessee shall pay rent at the then current monthly rental rate until returned, and Lessor shall also have the right to remove the leased property from Lessee's premises, without recourse to any legal proceedings.
10. **Repairs and Servicing.** If leased property, excluding Tool Bits, becomes worn or unserviceable from normal recommended use, Lessor will supply replacement tools and/or parts, without cost, upon return of the leased property to Lessor.
11. **Damage or Loss.** If leased property is damaged by reason of other than normal recommended use, Lessee shall indemnify Lessor for the cost of repairs. If leased property is not returned to Lessor in accordance with the terms of this Agreement for any cause or reason whatsoever, including, without limiting the generality of the foregoing, loss, theft, damage, accident, neglect, abuse or destruction, by fire or otherwise, whether due to Lessee's fault or not, Lessee shall pay to Lessor as liquidated damages an amount to be determined by Lessor not to exceed the list price of all leased property, as published in the most current Victaulic price list for Pipe Preparation tools.
12. **Indemnity.** Lessee assumes full responsibility for the operation of the leased property and shall indemnify, protect, save and keep harmless the Lessor, its agents and servants from and against all losses, damages, penalties, claims, actions, suits, costs, expenses and disbursements, including legal expenses of whatsoever kind in nature imposed upon, incurred by, or asserted against the Lessor in any way relating to or arising out of this Lease or of the Lessee's delivery, possession, use, operation or return of the leased property. The indemnities contained in this paragraph shall continue in full force and effect, notwithstanding the termination of this Lease.
13. **Lessor's remedies on default.** If the Lessee, with regard to any item or items of property, fails to pay any rent or other amount herein provided when the same shall become due and payable, or if the Lessee, with regard to any item or items of leased property, fails to observe, keep or perform any other provisions of this lease required to be observed, kept, or performed by the Lessee, or if any execution or other writ or process shall be issued in any action or proceeding against the Lessee, whereby the said leased property may be taken, the Lessor shall have the right to exercise any one or more of the following remedies:
  - (a) To declare the entire amount of rent hereunder immediately due and payable as to any or all items of leased property, without notice or demand to the Lessee.
  - (b) To sue for and recover all rents, and other payments, then accrued or thereafter accruing, with respect to any or all items of leased property.
  - (c) To take possession of any or all items of leased property without demand or notice, wherever the same shall be located, without any court order or other process of law. The Lessee hereby waives any and all damage occasioned by such taking of possession. Any said taking of possession shall not constitute a termination of this lease as to any or all items of leased property unless the Lessor expressly so notifies the Lessee in writing.
  - (d) To terminate this lease as to any or all items of leased property.
  - (e) To pursue any other remedy at law or in equity.Notwithstanding any such repossession or any other action, which the Lessor may take, the Lessee shall be and remain liable for the full performance of all obligations on its part to be performed under this lease; provided however, that if the Lessor is able to obtain any monies for said leased property from re-rental or sale thereof, which the Lessor specifically is not in any manner obligated to do, said monies, less expenses, shall be credited to the last payments of the Lessee's obligation. Waiver of any default herein is not a waiver of any subsequent default. All such remedies are cumulative and may be exercised concurrently or separately.
14. **Bankruptcy.** Neither this lease nor any interest therein is assignable or transferable by operation of law. If any proceeding under the Bankruptcy Act, as amended, is commenced by or against the Lessee, or if the Lessee is adjudged insolvent, or if the Lessee makes any assignment for the benefit of his creditors, or if a writ of attachment or execution is levied on any item or items of leased property and is not released or satisfied within 10 days thereafter, or if a receiver is appointed in any proceeding or action, to which the Lessee is a party, with authority to take possession or control of any item or items of the leased property, the Lessor shall have any may exercise any one or more of the remedies set forth in Paragraph 13 hereof; and this lease shall, at the option of the Lessor, without notice immediately terminate and shall not be treated as an asset of the Lessee after the exercise of said option.
15. **Concurrent Remedies:** The rights and remedies provided in this lease for the benefit of the Lessor shall be cumulative and shall not be exclusive but in addition to any other remedies to which the Lessor may be entitled. the Lessee waives trial by jury in any action or proceeding arising hereunder.
16. **Lessor's expenses:** The Lessee shall pay the Lessor all costs and expenses, including attorney's fees, incurred by the Lessor in exercising any of its rights or remedies hereunder or enforcing any of the terms, conditions, or provisions hereof.
17. **Binding Effect of Lease.** This lease agreement shall inure to the benefit of and be binding upon the parties hereto and their respective heirs, executors, administrators, personal or legal representatives, successors and assigns.
18. **Applicable Law and Severability.** This lease shall be governed by and construed under the laws of the State of Pennsylvania. If any provision herein is invalid, it shall be considered deleted from this lease, and shall not invalidate the remaining provisions of this lease.

# Pipe Preparation Tools

---

## TERMS AND CONDITIONS OF TOOL SALE

**Controlling Provisions:** These terms and conditions shall control with respect to any purchase order or sale of Victaulic products.

No alteration, modification or waiver of these terms and conditions whether on Customer's purchase order or otherwise shall be valid unless the alteration, modification or waive is specifically accepted in writing by an authorized representative of Victaulic.

Prices, Designs and Terms and Conditions of Sale are subject to change without notice.

**Minimum Order:** \$100.00 net for any single order.

**Terms of Payment:** As stated on invoice. Maximum permissible interest rate thereafter.

**Shipping Terms:** F.O.B. shipping point (our option), freight prepaid and allowed on single orders having a net price value of \$7,500 and over, for shipment at one time to one destination within the continental United States, excluding Alaska, Hawaii, Puerto Rico and U.S. possessions.

Shipments beyond the borders of the United States are prepaid and chargeable or collectable to final destination.

The most economical routing to recognized delivery points will be used, at our discretion. If special routing is desired, orders should so state.

Orders are accepted subject to approval of our General Office and Credit Department at Easton, Pennsylvania, and contingent upon **acts of God, war, civil disturbance, strikes, labor difficulties, delays of carriers, inability to obtain materials, accidents or any other cause beyond our control.**

Shipping dates are estimated as closely as possible. We use our best efforts to ship within the time estimated, but cannot guarantee to do so. In the event production or shipment is delayed, we reserve the privilege of changing shipping estimate. **Under no circumstances shall Victaulic be liable for damages of any kind, including but not limited to incidental or consequential damages for lost profits or lost sales or liquidated damages, directly or indirectly arising from delays or failure to meet shipping dates.**

Orders, when accepted, cannot be countermanded without our written consent. No material will be taken back without our written consent. Orders for non-standard material may not be cancelled nor will we accept return of such material for credit.

All material is carefully examined, counted and packed by experienced employees. Claims for corrections must be made within 10 days of receipt of goods. Our responsibility ceases when goods are delivered to carrier in good condition and its receipt obtained. Carriers are responsible for goods lost, damaged or delayed in transit. For your own protection, have transportation company's agent verify damages, shortages or delays and note them on freight bill over his signature.

**Weights:** All weights are approximate shipping weights and subject to change without notice.

**Victaulic Company maintains a continual policy of product improvement and, therefore, reserves the right to change product specifications, designs, and standard equipment without notice and without incurring obligation.**

## WARRANTY

Standard product warranty applies. See Inside Back Cover.

**NOTE: Reconditioned tools shall be warranted 30 days from date of purchase.**

---

## Terms and Conditions of Sale

**CONTROLLING PROVISIONS:** These terms and conditions shall control with respect to any purchase order or sale of Victaulic products.

**No alteration, modification or waiver of these terms and conditions whether on Customer's purchase order or otherwise shall be valid unless the alteration, modification or waiver is specifically accepted in writing by an authorized representative of Victaulic.**

Prices, Designs and Terms and Conditions of Sale are subject to change without notice.

**TERMS OF PAYMENT:** As stated on invoice. Maximum legal interest rate charged thereafter.

**MINIMUM INVOICE CHARGES:** \$100 net for any single order.

**SHIPPING TERMS:** F.O.B. shipping point (our option) freight prepaid and allowed on single orders having a net price value of \$7500 and over, for shipment at one time to one destination into distributor stock, as determined by Victaulic within the continental United States, excluding Alaska, Hawaii, Puerto Rico and U.S. possessions.

Shipping and handling charges on orders less than net price value of \$7500, F.O.B. shipping point (our option) will be paid by the customer. The most economical routing to recognized delivery points will be used, at our discretion. The cost of any special routing, packaging or handling that has been requested by the customer, and is a deviation to our normal handling methods, will be added to the order and paid by the customer.

Shipments beyond the borders of the United States are prepaid and chargeable or collectable to final destination.

Orders are accepted subject to approval of our General Office and Credit Department at Easton, Pennsylvania, and contingent upon **acts of God, war, civil disturbance, strikes, labor difficulties, delays of carriers, inability to obtain materials, accidents or any other cause beyond our control.**

Victaulic will endeavor to ship by the scheduled delivery date, but reserves the right to ship within a reasonable period thereafter. **Under no circumstances shall Victaulic be liable for damages of any kind, including but not limited to incidental or consequential damages for lost profits or lost sales or liquidated damages, directly or indirectly arising from delays or failure to meet shipping dates.**

Orders, when accepted, cannot be cancelled without our written consent. No material will be taken back without our written consent.

**Orders for non-standard (i.e. non-cancellable/non-returnable) material may not be cancelled nor will Victaulic accept return of such material for credit. Victaulic reserves the right to change the designation of products from standard to non-standard and vice versa. This may be done at any time without notice, and without incurring obligation. For further information contact Victaulic.**

All material is carefully examined, counted and packed by experienced employees. Claims for corrections must be made within 10 days of receipt of goods to the Customer Care center in Easton, PA (1-800-PICK VIC). We prove our count by weight. Claims for shortages are subject to that test. Our responsibility ceases when goods are delivered to carrier in good condition and its receipt obtained. Carriers are responsible for goods lost, damaged or delayed in transit. For your own protection, have transportation company's agent verify damages, shortages or delays and note them on freight bill over his signature.

**WEIGHTS:** All weights are approximate shipping weights and subject to change without notice.

Victaulic maintains a continual policy of product improvement and, therefore, reserves the right to change product specifications, designs, and standard equipment without notice and without incurring obligation.
---

## Warranty

We warrant all products to be free from defects in materials and workmanship under normal conditions of use and service. Our obligation under this warranty is limited to repairing or replacing at our option at our factory any product which shall within one year after delivery to original buyer be returned with transportation charges prepaid, and which our examination shall show to our satisfaction to have been defective.

THIS WARRANTY IS MADE EXPRESSLY IN LIEU OF ANY OTHER WARRANTIES, EXPRESS OR IMPLIED, INCLUDING ANY IMPLIED WARRANTY OF MERCHANTABILITY OR FITNESS FOR A PARTICULAR PURPOSE. THE BUYER'S SOLE AND EXCLUSIVE REMEDY SHALL BE FOR THE REPAIR OR REPLACEMENT OF DEFECTIVE PRODUCTS AS PROVIDED HEREIN. THE BUYER AGREES THAT NO OTHER REMEDY (INCLUDING, BUT NOT LIMITED TO, INCIDENTAL OR CONSEQUENTIAL DAMAGES FOR LOST PROFITS, LOST SALES, INJURY TO PERSON OR PROPERTY OR ANY OTHER INCIDENTAL OR CONSEQUENTIAL LOSS) SHALL BE AVAILABLE TO HIM.

Victaulic neither assumes nor authorizes any person to assume for it any other liability in connection with the sale of such products.

**This warranty shall not apply to any product which has been subject to misuse, negligence or accident, which has been repaired or altered in any manner outside of Victaulic's factory or which has been used in a manner contrary to Victaulic's instructions or recommendations. Victaulic shall not be responsible for design errors due to inaccurate or incomplete information supplied by Buyer or its representatives.**

Items purchased by Victaulic and resold will have the original equipment manufacturer's warranty extended to Victaulic customers.

EFFECTIVE AUGUST 4, 2008

# Piping. Systems. Solutions.

www.victaulic.com

The Victaulic website is an information resource that can help you with your piping projects. Among the many resources available at the site:

- Fully searchable product and project databases
- Free product submittals
- Free product literature
- Piping software demos and modules
- Information on new product innovations
- Support services, and more...

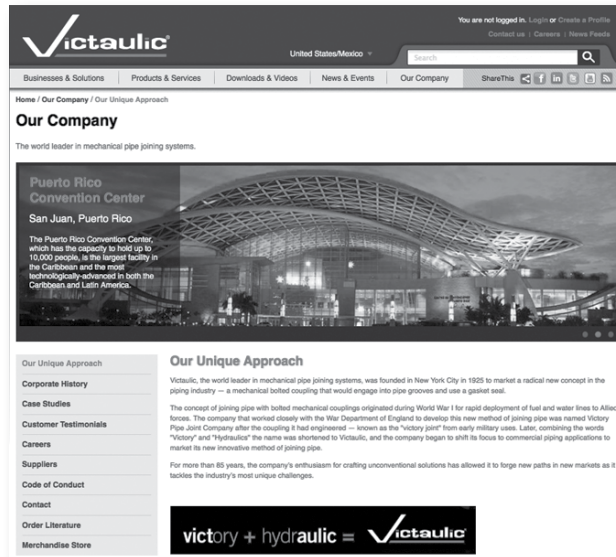

## VICTAULIC

### WORLD HEADQUARTERS

P.O. Box 31  
Easton, PA 18044-0031 USA

4901 Kesslersville Road  
Easton, PA 18040 USA

1-800-PICK-VIC  
(1-800-742-5842)  
1-610-559-3300  
1-610-250-8817 (fax)  
pickvic@victaulic.com

www.victaulic.com

### UNITED STATES

P.O. Box 31  
Easton, PA 18044-0031

4901 Kesslersville Road  
Easton, PA 18040 USA

1-610-559-3300  
1-610-250-8817 (fax)  
pickvic@victaulic.com

### CENTRAL AND SOUTH AMERICA

P.O. Box 31  
Easton, PA 18044-0031 USA

4901 Kesslersville Road  
Easton, PA 18040 USA

1-610-559-3300  
1-610-559-3608 (fax)  
vical@victaulic.com

UPDATED 6/2012

PL2012-AWWA 1617 REV X

VICTAULIC IS A REGISTERED TRADEMARK OF VICTAULIC COMPANY. © 2012 VICTAULIC COMPANY. ALL RIGHTS RESERVED.

